

**ZEKIN<sup>®</sup>**

— DOORS AND WINDOWS —

**HIGH-END SYSTEM DOORS AND WINDOWS**

Foshan Desilesi Home Technology Co., Ltd.



## LEADING BRAND OF HIGH-END SECURITY DOORS AND WINDOWS

---

Foshan Desles Home Technology Co., Ltd. is a well-known door and window enterprise specializing in the manufacturing, sales and service of doors and Windows. ZEKIN High-End Security Doors and Windows is one of its high-end brands. Founded in 2008, it has 17 years of experience in customizing high-end security doors and Windows and a modern intelligent manufacturing base covering over 155,000 square meters. With its strong brand influence, it has been listed among the top 500 Chinese brands in terms of brand value for three consecutive years and has been recognized as a landmark brand in the Chinese doors and Windows industry. It has won the German IF and German Red Dot Design Awards. High-end security doors and Windows have led the national sales for three consecutive years, and its solid strength has firmly maintained its leading position in China's high-end security doors and Windows industry.

Foshan Desles Home Technology Co., Ltd. offers a one-stop, full-category solution covering casement Windows, swing doors, sliding Windows, sliding doors, folding doors, sunrooms, aluminum-wood doors, shower rooms, curtain wall series and all-aluminum system armored doors, etc. It is committed to providing global users with a high-quality home experience in all aspects.

## PRODUCTION WORKSHOP



## EXHIBITION HALL DISPLAY



## TEAM STYLE



## CUSTOM MANUFACTURING PROCESS FOR DOORS AND WINDOWS

### SECTION EXTRUSION



### SURFACE TREATMENT



# CUSTOM MANUFACTURING PROCESS FOR DOORS AND WINDOWS

## GLASS PROCESS



Raw glass sheet



Glass cutting production line



Glass tempering process



Glass laminating process

## PRODUCT ASSEMBLY



## EX-FACTORY INSPECTION



## PRODUCT PACKAGING



## CONTAINER SHIPMENT



THE MOST INFLUENTIAL BRAND  
SPOKESPERSON IN THE  
DOOR AND WINDOW INDUSTRY

IMAGE  
AMBASSADOR *Donnie  
Yen*



HIGH-END SECURE DOORS  
AND WINDOWS  
NEED TO HAVE ZHEN KUNG FU

VILLAS, LUXURY HOMES, HIGH-END DECORATION SPECIAL DOORS AND WINDOWS  
ZEKIN BRAND IMAGE AMBASSADOR DONNIE YEN

# DOOR AND WINDOW INDUSTRY----- THE MOST INFLUENTIAL BRAND AMBASSADOR

International kung fu star Donnie Yen served as the image ambassador of Foshan Desles Home Technology Co., Ltd. ZEKIN Doors and Windows, the brand is focusing on customer experience and service. In today's fast-paced and ever-changing business landscape, developing a strong brand is crucial for success..



LEADING BRAND OF HIGH-END SAFETY DOORS AND WINDOWS  
**TOP 500** CHINESE BRANDS  
THE BRAND VALUE OF FOSHAN DESLES HOME TECHNOLOGY CO., LTD.  
ZEKIN DOORS AND WINDOWS

REACHED **2,535,000,000 USD**  
**LEADING INDUSTRY POSITION**



# MULTIPLE BRAND HONORS LEAD BY STRENGTH

- In 2016, it was rated as "Excellent brand of Guangdong Door Industry".
- In 2018, it was awarded "Member of the Council of China Building Materials Circulation Association".
- Named "Consumer Favorite Brand" in 2019
- In 2019, it won the honor of "Top 100 Chinese Door and Window Brands"
- In 2019, it won the honor of "China's Preferred Brand"
- In 2020, it won the title of "Influential Enterprise"
- In 2020, it won the honor of "Top 100 Chinese door and Window Brands"
- 2021 "Custom home aluminum alloy casement window" standard participation unit
- 2021 won the door and window industry "comprehensive strength of the top ten brands" award
- In 2021, won the award of "China Building Materials Home Furnishing - Top Ten brands of doors and Windows"
- In 2021 won the "brand power" doors and Windows industry demonstration unit
- In 2021, it was awarded the honor of "Vice Chairman Unit of China Building Materials Circulation Association"
- In 2021, it won the award of "Top Ten brands of Aluminum alloy Doors and Windows Brand Value"
- 2022 "Custom doors and Windows engineering technical specifications" participating units
- In 2022, it was awarded the vice president unit of "Guangdong Door and Window Association"
- In 2022, won the "Gold Enterprise" award of China's system door and window industry in 2023, won the top 500 Chinese brand value
- 2023 won the ninth China door and window industry iconic brand
- 2023 Won the home green environmental protection recommended brand
- 2023 "IF Design Award in Germany"
- 2023 Himalayan Design Summit Award
- In 2023, he won the MUSE Design Award in the United States
- 2023 home leading brand
- 2023 Influential brand
- China's high-end security doors and Windows sales leader for three consecutive years
- 2024 China Home Fashion Festival set G20 brands
- 2024 German Red Dot Design Award
- 2024 IAI Global Design Award - Smart Design Award



德国红点奖 | 德国IF设计奖 | 中国品牌价值500强企业 | 中国行业标志性品牌 | 中国绿色建材产品认证 | 2024年GGSA高定G20品牌  
中国系统门窗行业品牌TOP30 | 家居绿色环保推荐品牌 | 2023年度家居领军品牌 | 2023年度影响力品牌

# GREEN LOW-CARBON LEADING DOOR AND WINDOW INDUSTRY

The first enterprise in the industry to obtain the national honor of "China Green Building Materials Product Certification", promote the high-quality sustainable development of the industry, and make contributions to the optimization and improvement of the ecological environment as a national certification enterprise with social responsibility.



institutional framework, physical infrastructure and administrative services that will ensure a complete smooth operation to support the various economic activities within the Industrial park.

## DESLES DOORS ANDWINDOWS INVESTED

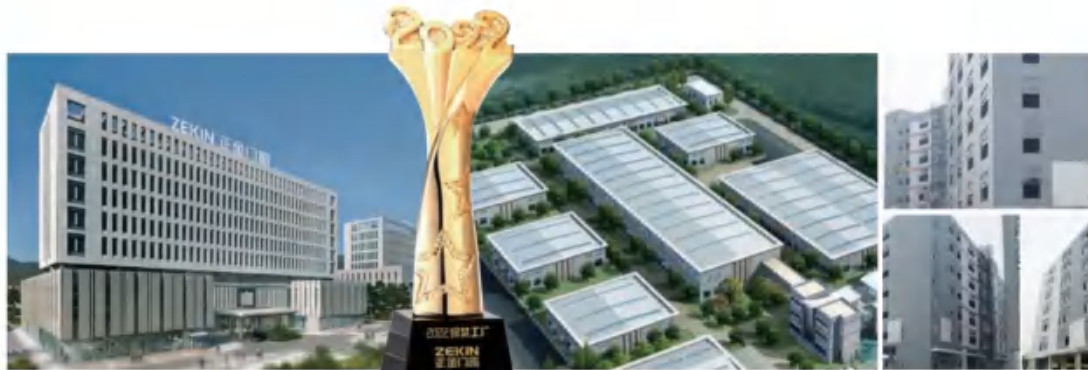

HAS A NATIONAL DOOR AND WINDOW TESTING CENTER

## INTERNATIONAL AUTHORITATIVE CERTIFICATION LEADING STRENGTH



( American Standard )



( Australian Standard )

# QUALITY ESCORT

ISO 9001:2015 Quality Management system standard  
 SO 14001:2015 Environmental Management system standard



# EUROPEAN ASSURANCE OF QUALITY

EU CE certified brand



# WON THE 2023 IF DESIGN AWARD IN GERMANY

The ingenuity of the design shows "Zhen" kung fu



# WON THE MUSE DESIGN SILVER AWARD

Innovative aesthetic design, highly recognized



# ZEKIN DOORS AND WINDOWS

186 national patents industry-leading



# STANDARD PRODUCTION AUTHORITY SUPERVISION

Foshan Desles Home Technology Co., Ltd. from the quality control standards, production technology, factory inspection standards and other whole process through the national authority unitsupervision, calibration, testing qualified, quality assurance.



## Casement window

- 11 40 non-thermal break series (construction style)
- 13 50 non-thermal break series
- 15 60 thermal break series
- 17 97 series thermal break double inside open
- 19 82 series thermal break double inside open
- 21 87 thermal break series
- 23 65 thermal break series
- 25 100 thermal break top-hung series, Standard with screen
- 27 103 thermal break series, Standard with screen
- 29 20116 thermal break series, Standard with screen

## Sliding window

- 31 728 series non-thermal break sliding window ( construction style )
- 33 90series non-thermal break sliding window ( construction style )
- 35 80 series thermal break sliding window (2 tracks)
- 37 120 series thermal break sliding window (3 tracks)
- 39 88 series thermal break sliding window(2 tracks)
- 41 135 series thermal break sliding window(3 tracks)
- 43 120 series non-thermal break sliding window(3 tracks)
- 45 80 series non-thermal break sliding window(2 tracks)

## Sliding door

- 47 90/137series non-thermal break sliding door(3 tracks)
- 49 4535 series non-thermal break sliding door
- 51 180/65 series non-thermal break sliding door
- 53 120/190 series thermal break lift and sliding door
- 55 80/120 series non-thermal break sliding door
- 57 88/135 series thermal break sliding door(2 tracks)
- 59 85 series thermal break Hide hinge folding door
- 61 86 series thermal break Hide hinge folding door

- 63 88series thermal break open hinge folding door
- 65 90series thermal break Hide hinge folding door
- 67 95series thermal break Hide hinge folding door

## Single hung window

- 69 60series thermal break folding window
- 71 55series non-thermal break up and down folding window
- 73 83series thermal break up and down single hung window

## Curtain wall

- 75 100series
- 77 120series
- 79 140series
- 81 180series

## KFC door

- 83 55 series KFC door/Spring door
- 85 80 series KFC door/Spring door

## Skylight

- 87 Fixed skylight
- 88 Electric skylight

## Interior casement door

- 91 4516 series casement door
- 93 4535 series casement door

## Interior sliding door

- 95 4516 series sliding door
- 97 4535 series sliding door

## Outdoor extremely narrow panoramic sliding door

- 99 Panoramic two-track thermal break sliding door

---

# CONTENTS

## COMPANY PROFILE

01-02 FACTORY STRENGTH

03 BRAND IMAGE ENDORSER

04-09 HONORARY CERTIFICATES

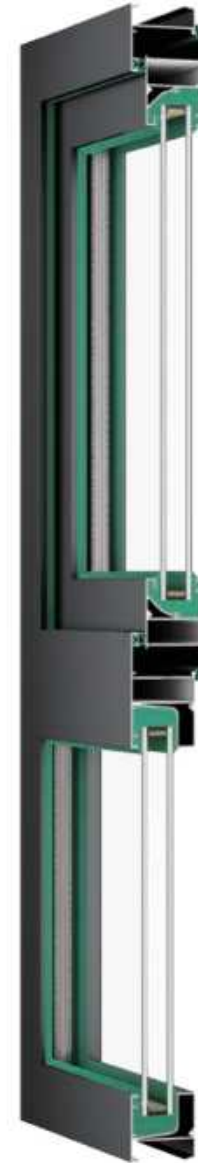
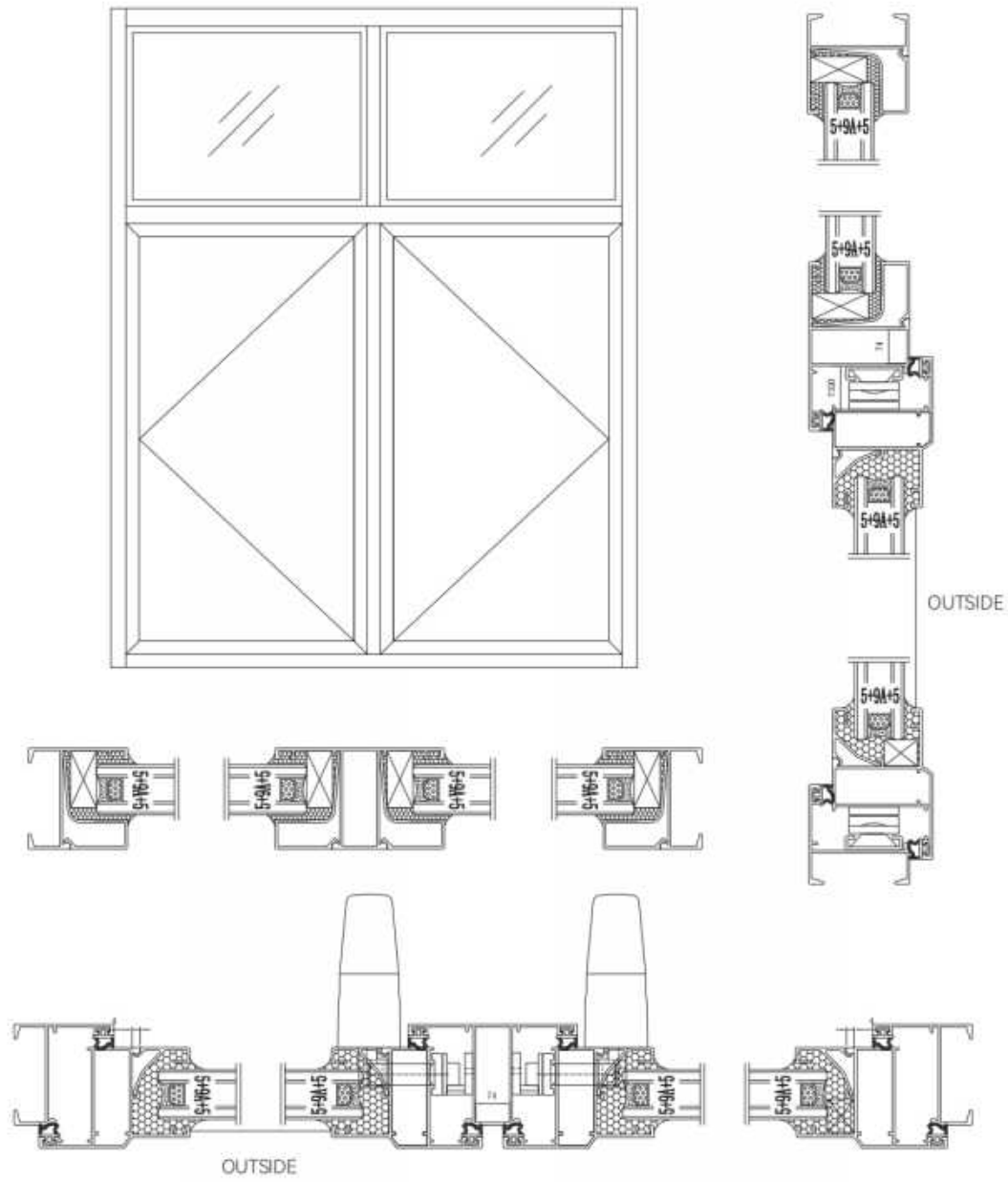

SHOWCASE GRAPH

# 50 NON-THERMAL BREAK SERIES

# HIGH-END SYSTEM DOORS AND WINDOWS

### Technical Parameters:

Frame thickness: 1.4mm

### Size rang:

Sash width 450mm-750mm, Sash height 750mm-1400mm

### Glass specification:

5mm+9A+5mm double clear tempered glass

### Heat insulation strip:

Non-broken bridge

### Product function:

Outward opening/outward overhanging/inward opening and inward tilting

### Product advantage:

1. 45 degree corner cleat with glue injection design has stable structure, elegant and smooth appearance lines
2. The sash is designed with beveled lines, revealing a sense of aesthetic design in fashionable simplicity
3. Stainless steel load-bearing hardware, has safe and stable without deformation performances, and long service life
4. Standard 6+12A+6 hollow tempered glass, has good sound insulation, heat insulation, and better safety

## PRODUCT ACCESSORIES



Bend Handle - Lock Block - "T"Shaped Piece



## HARDWARE CONFIGURATION

*Simplicity The minimalist design concept eliminates unnecessary decorations and creates a peaceful and comfortable living space.*

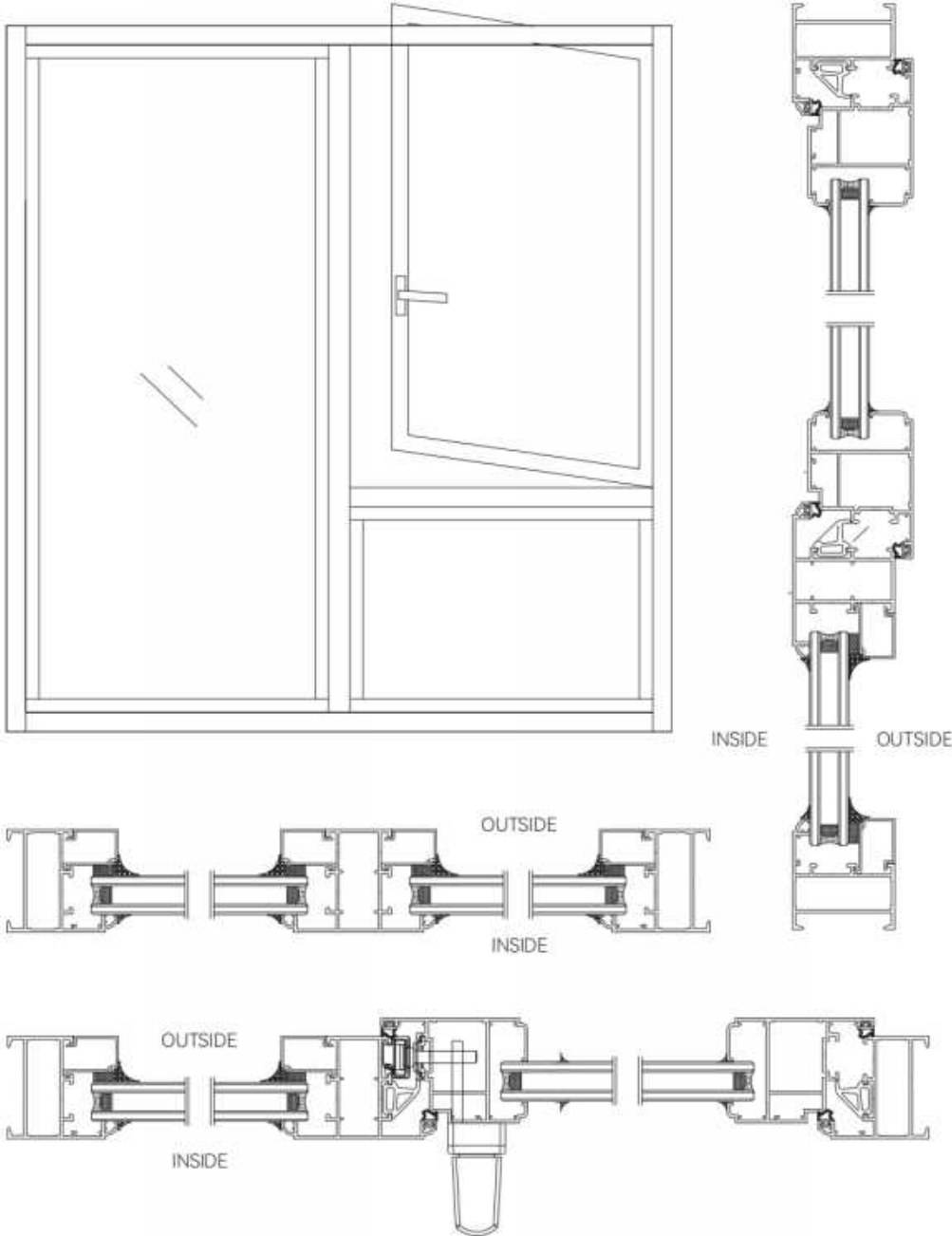

SHOWCASE GRAPH

# 60 THERMAL BREAK SERIES

# HIGH-END SYSTEM DOORS AND WINDOWS

### Technical Parameters:

Frame thickness: 1.4mm

### Size rang:

Sash width 700mm-5000mm, Sash height 1400mm-3000mm

### Glass specification:

5mm+12A+5mm double clear tempered glass

### Heat insulation strip:

Frame type C: 18mm, fan type C: 27mm

### Product function:

Outward opening/outward overhanging/inward opening and inward tilting

### Product advantage:

- 1、 simple design, improve the overall beauty of the home
- 2、 excellent sealing performance, effective energy saving and consumption reduction
- 3、 high-end hardware accessories, durable
- 4、 high-quality materials, safe and stable structure



## PRODUCT ACCESSORIES



## HARDWARE CONFIGURATION



Simplicity The minimalist design concept eliminates unnecessary decorations and creates a peaceful and comfortable living space.

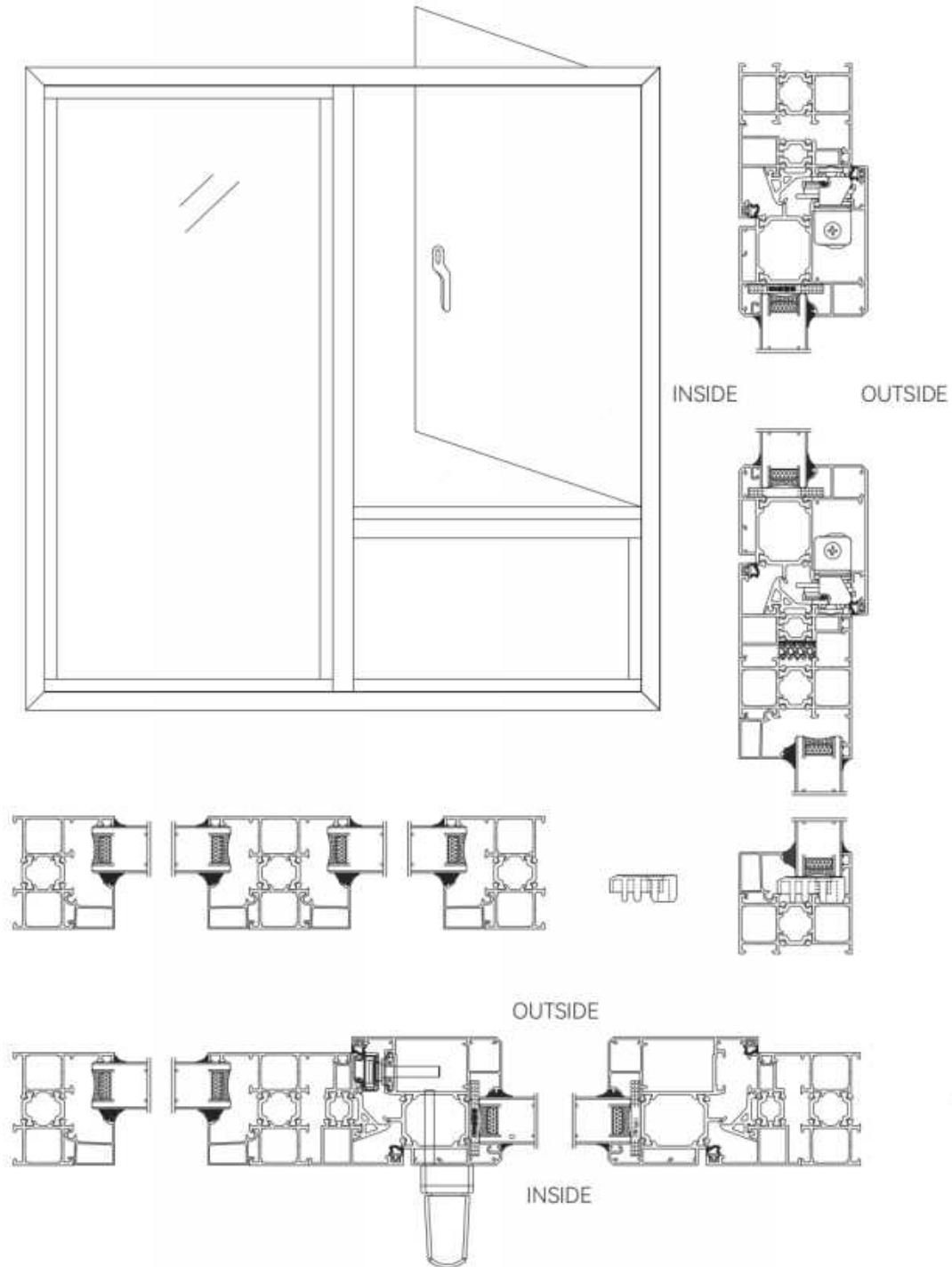

SHOWCASE GRAPH

# 97 SERIE

(THERMAL BREAK DOUBLE INSIDE OPEN )

# HIGH-END SYSTEM DOORS AND WINDOWS

### Technical Parameters:

Frame thickness: 1.8mm

### Size rang:

Sash width 500mm-750mm, Sash height 800mm-1400mm

### Glass specification:

5mm+27A+5mm double clear tempered glass

### Heat insulation strip:

35.3mm

### Product function:

Single inside opening Open inward and tilt inward

### Product advantage:

1. No obstruction of vision, large light and transparent space
2. Seamless structure design, sound insulation and dustproof, good sealing performance
3. Smooth lines of the whole window, beautiful and atmospheric, strong adaptability to the scene

## PRODUCT ACCESSORIES



Roto Transmission Box For Tilt & Turn,  
Lock Set, Corner Connector



Roto Accessories For Tilt & Turn

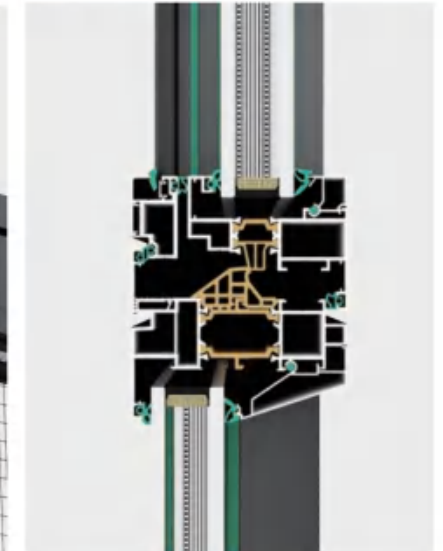

## HARDWARE CONFIGURATION

Simplicity The minimalist design concept eliminates unnecessary decorations and creates a peaceful and comfortable living space.

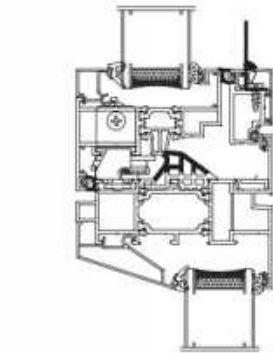
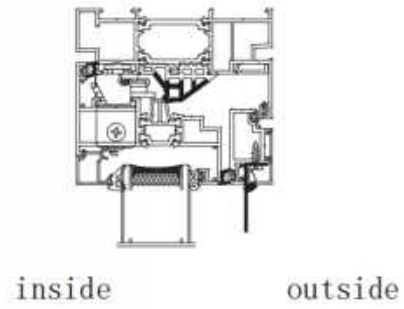
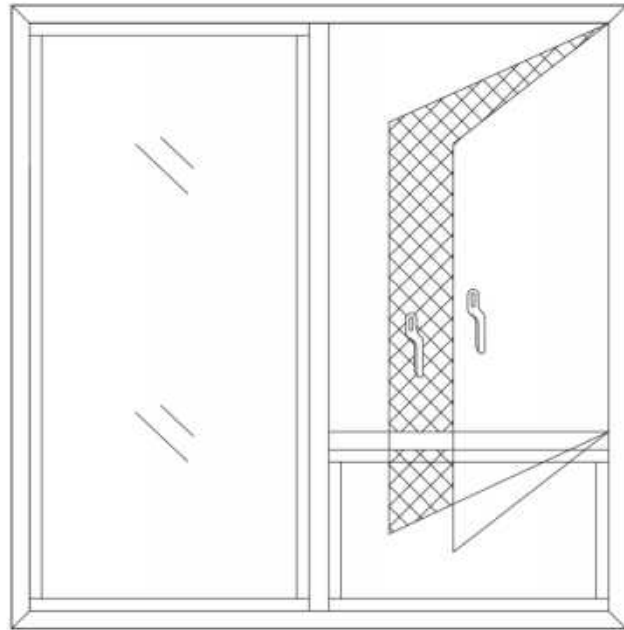

outside

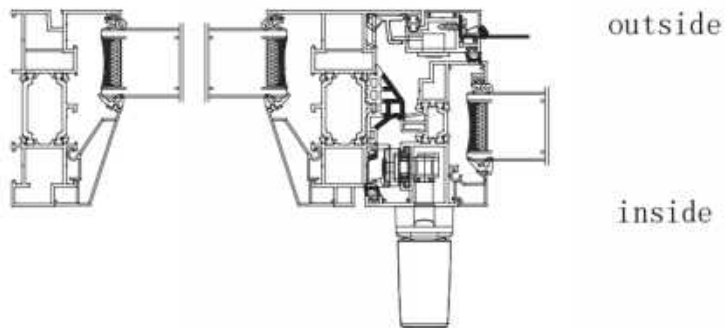
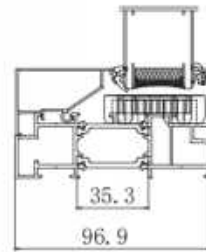
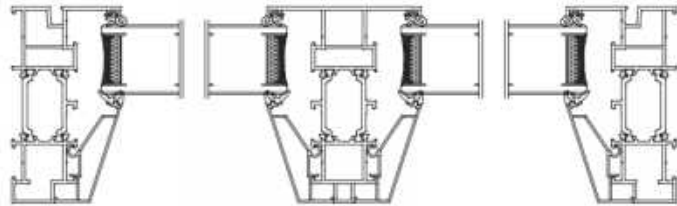

SHOWCASE GRAPH

# 82 SERIE

( THERMAL BREAK DOUBLE INSIDE OPEN )

# HIGH-END SYSTEM DOORS AND WINDOWS

### Technical Parameters:

Frame thickness: 1.8mm

### Size rang:

Sash width 500mm-750mm, Sash height 800mm-1400mm

### Glass specification:

5mm+24A+5mm double clear tempered glass

### Heat insulation strip:

30mm

### Product function:

Single inside opening Open inward and tilt inward

### Product advantage:

1. Reinforced wall thickness design has higher safety performance, higher wind pressure resistance
2. The corner cleat injection process not only increases the structural stability of the window, but also improves the 5 major performance of the window.
3. Three seals with isothermal perpendicular lines for excellent thermal insulation performance
4. Adopting 304 stainless steel high-transparency mesh, provides better ventilation and visual effect

## PRODUCT ACCESSORIES



Roto Transmission Box For Tilt & Turn,  
Lock Set, Corner Connector

Roto Accessories For Tilt & Turn

HOPPE Handle



## HARDWARE CONFIGURATION

*Simplicity The minimalist design concept eliminates unnecessary decorations and creates a peaceful and comfortable living space.*

82 SERIES THERMAL BREAK DOUBLE INSIDE OPEN

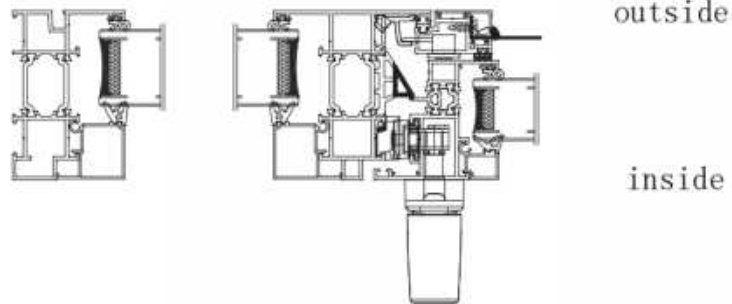
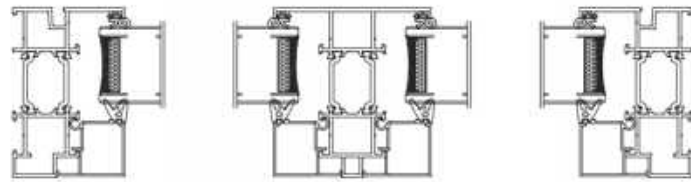
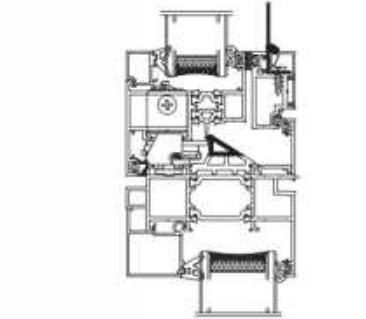
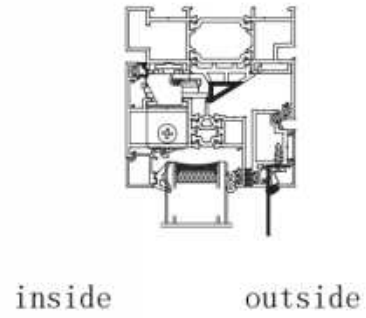
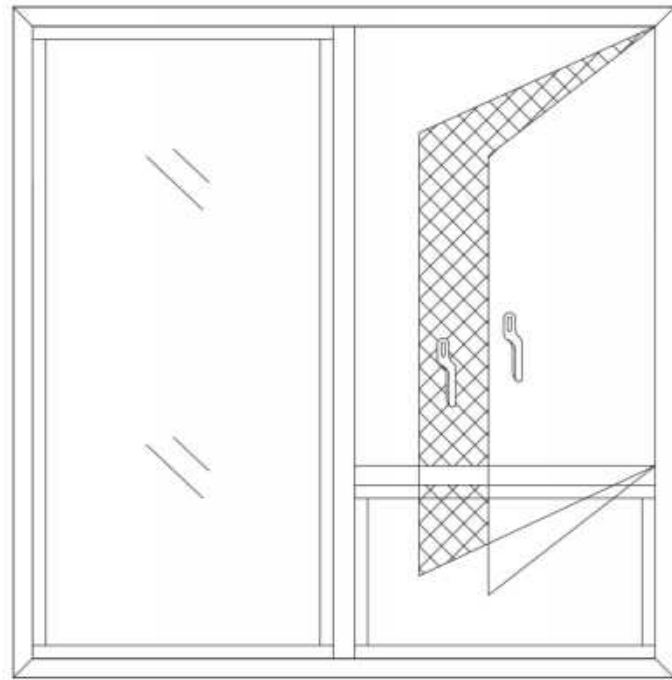

SHOWCASE GRAPH

# 87 THERMAL BREAK SERIES

# HIGH-END SYSTEM DOORS AND WINDOWS

### Technical Parameters:

Frame thickness: 1.8mm

### Size rang:

Sash width 500mm-750mm, Sash height 800mm-1400mm

### Glass specification:

5mm+24A+5mm double clear tempered glass

### Heat insulation strip:

35.3mm

### Product function:

Outward-opening/outward-overhanging/inward-opening and inward-tilting/  
outward-opening/inward-opening

### Product advantage:

1. Isothermal vertical with 35.3mm heat-insulating strips, effectively prevents heat transfer, and has excellent thermal insulation performance
2. Split balanced Angle code injection process, improve the wind pressure resistance of the whole window and the overall safety performance
3. Provide fancy color custom design to break the traditional monotony and make the windows become the highlight of home decoration

## PRODUCT ACCESSORIES



SI Transmission Box For Tilt & Turn,  
Lock Set, Corner Connector



SI Accessories For Tilt & Turn



HOPPE Handle

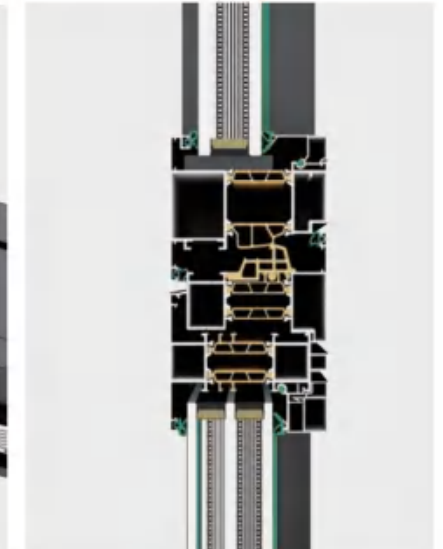

## HARDWARE CONFIGURATION

*Simplicity The minimalist design concept eliminates unnecessary decorations and creates a peaceful and comfortable living space.*

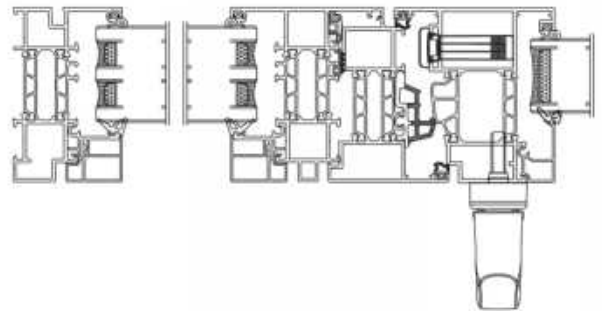
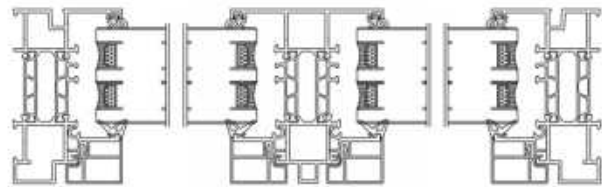
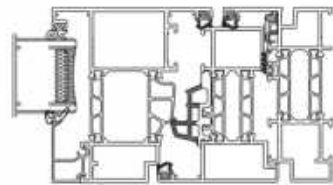
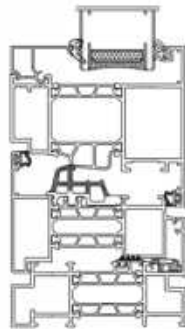
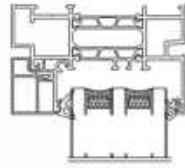
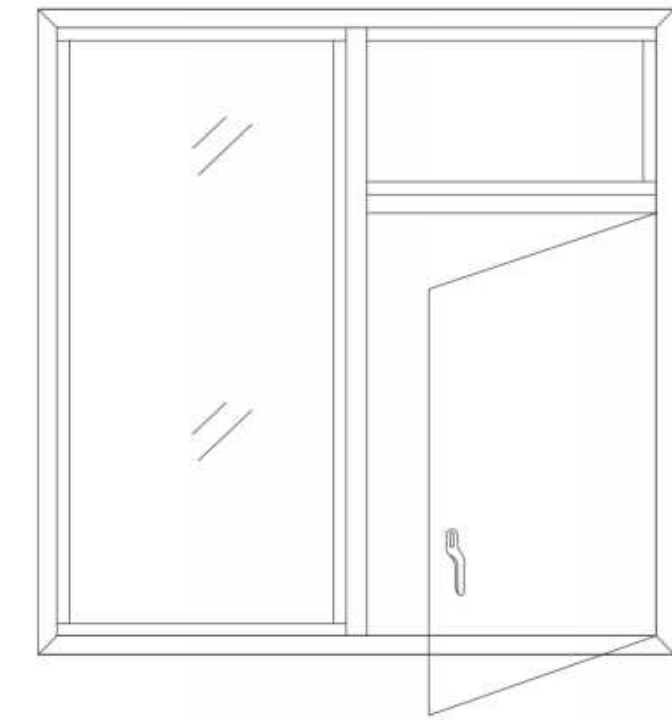

SHOWCASE GRAPH

# 65 SERIE

( THERMAL BREAK )

# HIGH-END SYSTEM DOORS AND WINDOWS

### Technical Parameters:

Frame thickness: 1.8mm

### Size rang:

Sash width 500mm-750mm, Sash height 800mm-1400mm

### Glass specification:

5mm+20A+5mm double clear tempered glass

### Heat insulation strip:

22mm

### Product function:

Outward-opening/outward-overhanging/inward-opening and inward-tilting/  
outward-opening/inward-opening

### Product advantage:

- 1、 Split balanced Angle code injection process, improve the wind pressure resistance of the whole window and the overall safety performance
- 2、 Three-layers sealing with isothermal vertical line design, has excellent heat preservation and insulation performance
- 3、 Doors windows can be made, with glass protection integrated design, it looks noble and elegant and enhances the overall style of the home

## PRODUCT ACCESSORIES



Hinges For The Sash



Handle-Transmission Box For Sashes

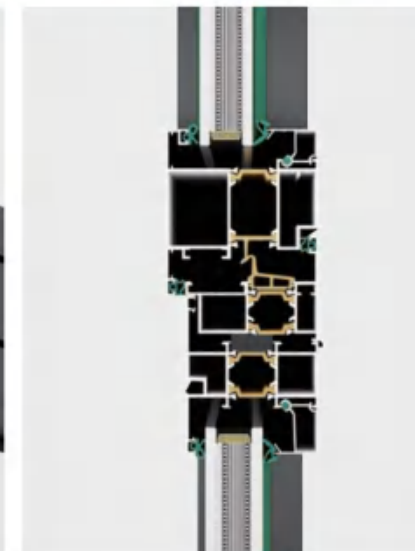

## HARDWARE CONFIGURATION

*Simplicity The minimalist design concept eliminates unnecessary decorations and creates a peaceful and comfortable living space.*

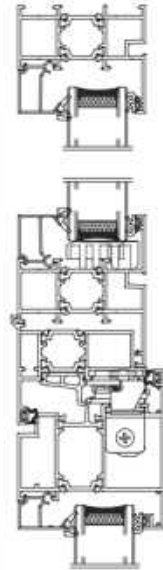
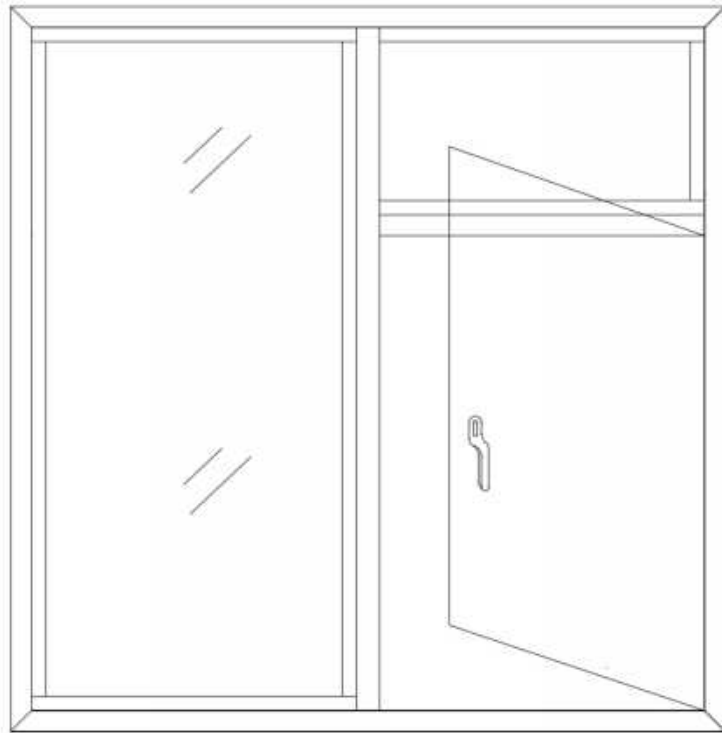

inside outside

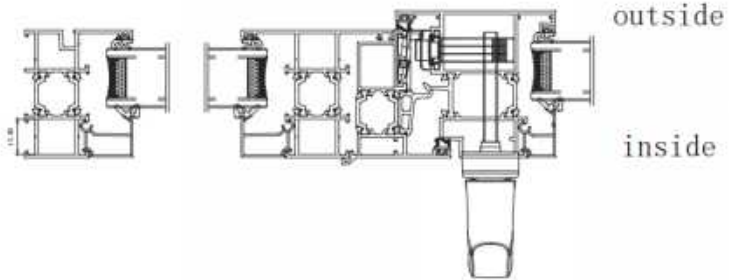
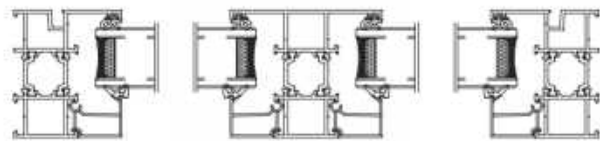

outside

inside



SHOWCASE GRAPH

# 100 THERMAL BREAK TOP-HUNG SERIE

(STANDARD WITH SCREEN)

## HIGH-END SYSTEM DOORS AND WINDOWS

### Technical Parameters:

Frame thickness: 1.8mm

### Size rang:

Sash width 500mm-750mm, Sash height 800mm-1400mm

### Glass specification:

5mm+20A+5mm double clear tempered glass

### Heat insulation strip:

26mm

### Product function:

Outward opening/outward overhanging

### Product advantage:

1. Reinforced wall thickness design has higher safety performance, higher wind pressure resistance
2. Split balanced Angle code injection process, improve the wind pressure resistance of the whole window and the overall safety performance
3. 20A hollow thickness effectively improves sound insulation, heat preservation and thermal insulation properties



## PRODUCT ACCESSORIES



## HARDWARE CONFIGURATION



*Simplicity The minimalist design concept eliminates unnecessary decorations and creates a peaceful and comfortable living space.*

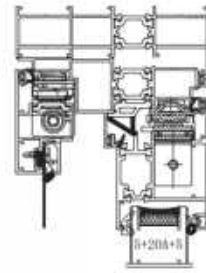
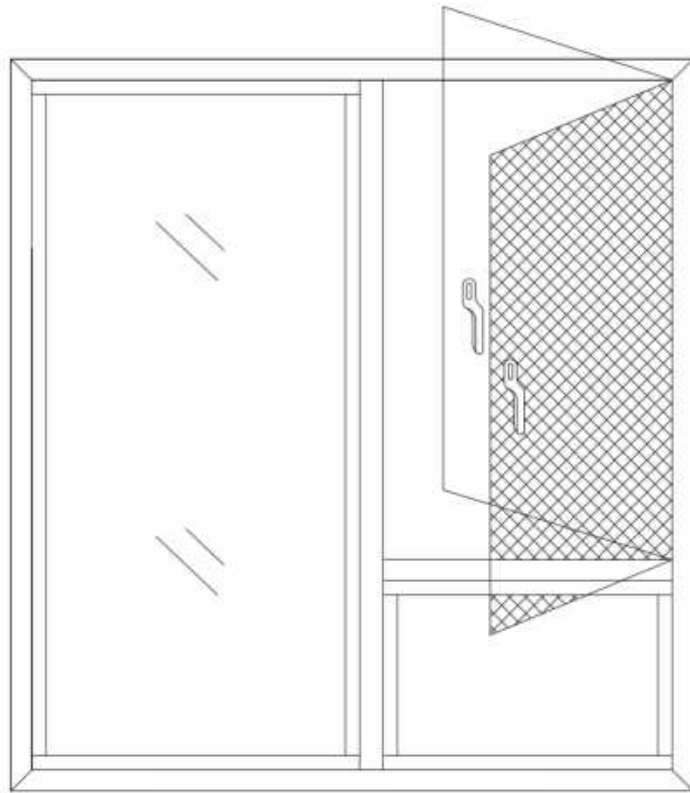

inside outside

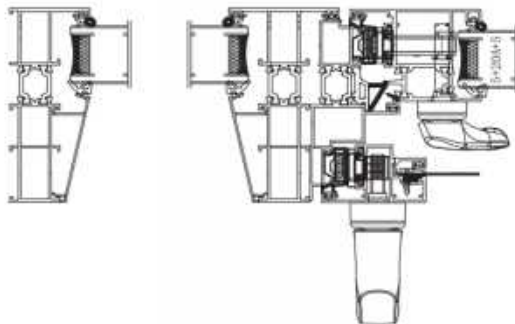
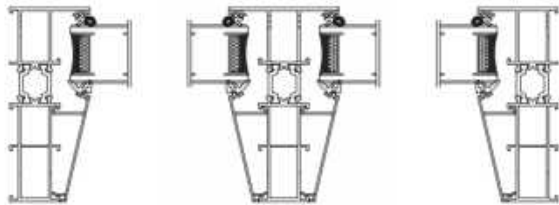
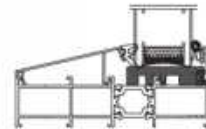
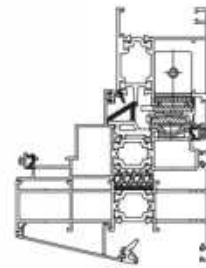

outside

inside

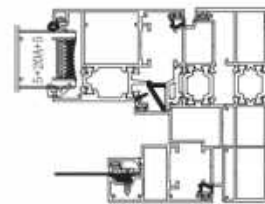

SHOWCASE GRAPH

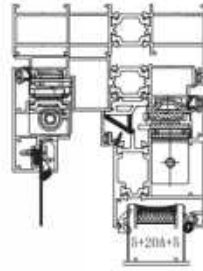
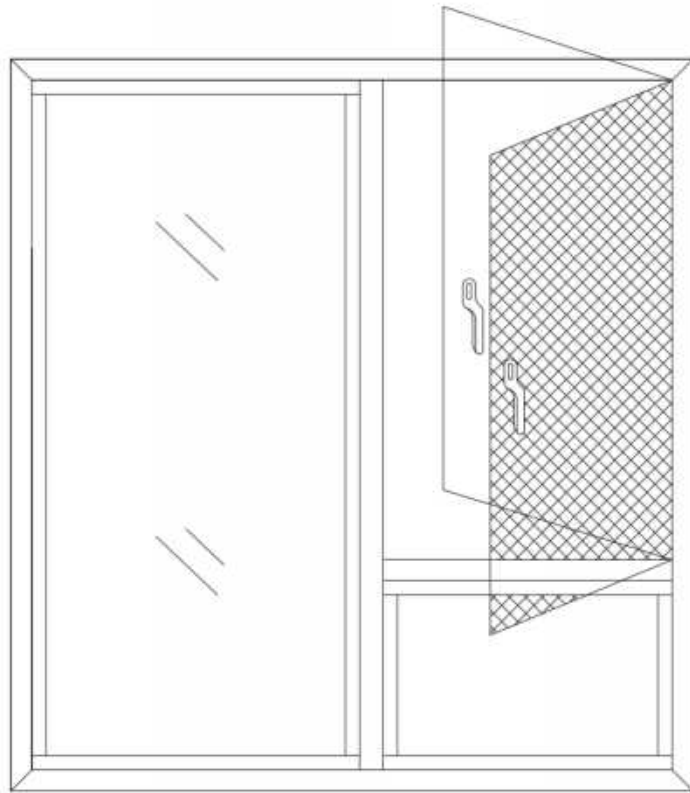

inside outside

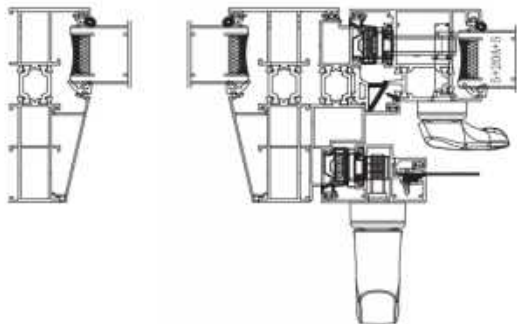
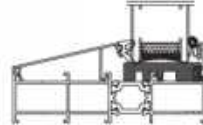
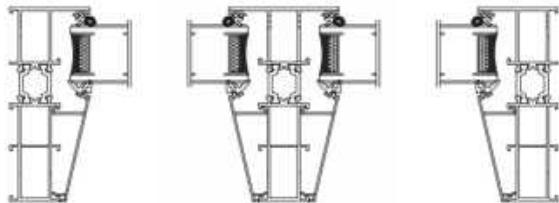
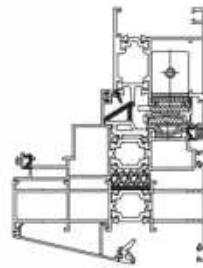

outside

inside

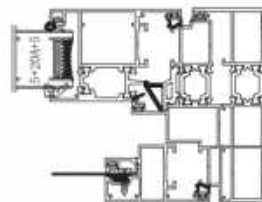

SHOWCASE GRAPH

# 103 THERMAL BREAK SERIES

(STANDARD WITH SCREEN)

## HIGH-END SYSTEM DOORS AND WINDOWS

### Technical Parameters:

Frame thickness: 1.8mm

### Size rang:

Sash width 500mm-750mm, Sash height 800mm-1400mm

### Glass specification:

5mm+20A+5mm double clear tempered glass

### Heat insulation strip:

22mm

### Product function:

Outward opening/outward overhanging

### Product advantage:

1. Concealed pull handle with strike plate has its own flip-up nut which is simple and strong
2. 26mm narrow edge design allows for a wider field of view
3. Inside and outside flat frame design, looks beautiful and practical, and has longer service life for rubber strips
4. The window screen features a anti-children spring lock which is more delicate and safe



## PRODUCT ACCESSORIES

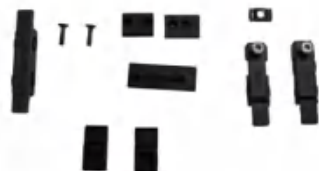

Lock Blocks & Lock Set For Sashes



Screen Lock, screen Hinges, Lock Blocks & Lock Set For Screens



Hinges For The Sash



Sash Lock- Transmission Box For Sashes

## HARDWARE CONFIGURATION

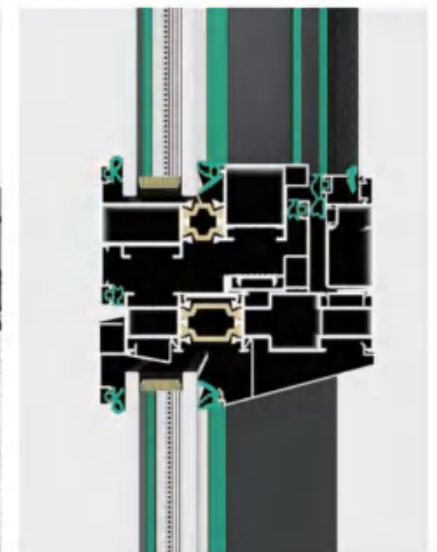

Simplicity The minimalist design concept eliminates unnecessary decorations and creates a peaceful and comfortable living space.

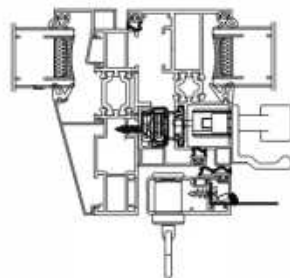
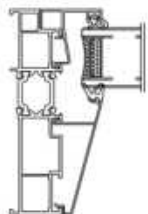
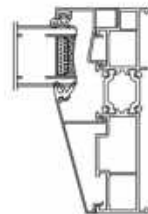
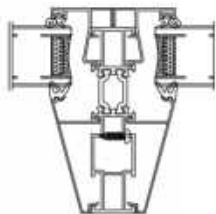
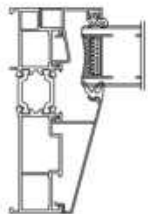
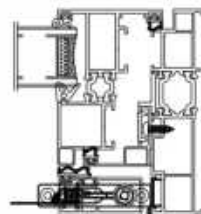
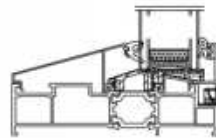
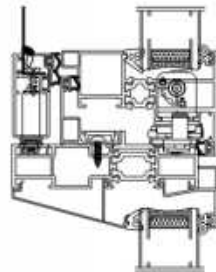
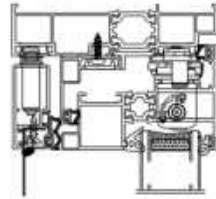
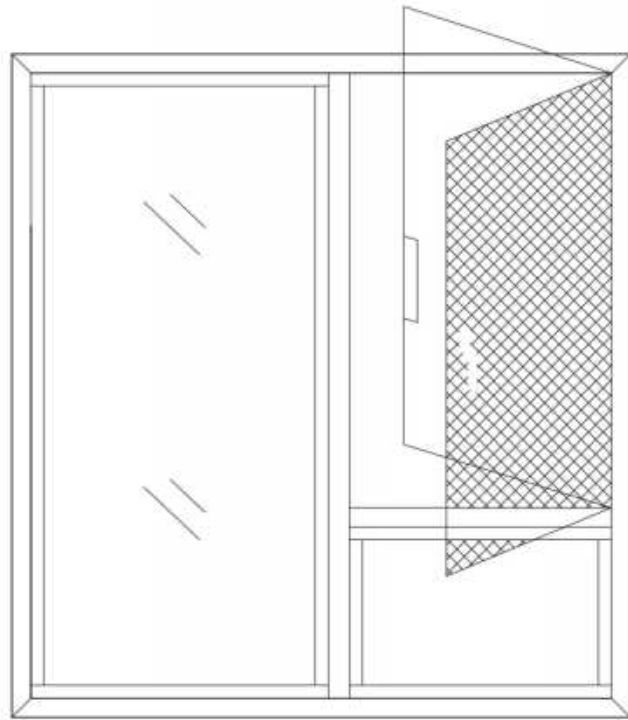

SHOWCASE GRAPH

# 2016 THERMAL BREAK SERIES

(STANDARD WITH SCREEN)

## HIGH-END SYSTEM DOORS AND WINDOWS

### Technical Parameters:

Frame thickness: 2.0mm

### Size rang:

Sash width 500mm-750mm, Sash height 800mm-1400mm

### Glass specification:

5mm+20A+5mm double clear tempered glass

### Heat insulation strip:

25.3mm

### Product function:

Outward opening/outward overhanging/inward opening and inward tilting

### Product advantage:

1. Broken bridge structure design, excellent thermal insulation performance
2. Corner code injection process, increase the stability of the window structure, enhance the window 5 performance
3. 2.0mm profile wall thickness, higher safety and wind pressure resistance.
4. High-end brand hardware, quality assurance, more durable and long-lasting.
5. Solid oversized glass, more resistant to wind pressure and safer.

## PRODUCT ACCESSORIES



Transmission Box For Sashes-Transmission Box For Screens- Hinges For Screens



SI Transmission Box For Tilt & Turn - Lock Set - Corner Connector



Hoppe Press Handle



Hinges For Sashes



Hoppe Bend Handle



Hoppe Bend Handle

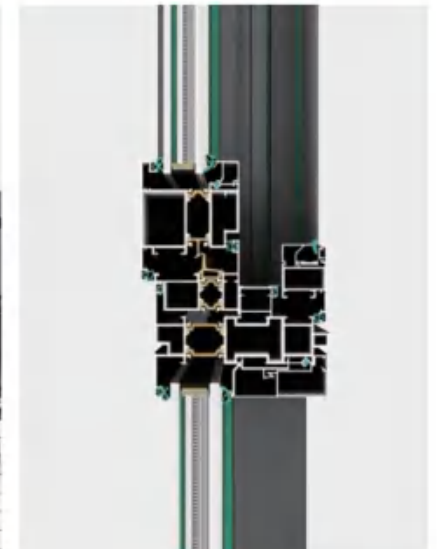

## HARDWARE CONFIGURATION

Simplicity The minimalist design concept eliminates unnecessary decorations and creates a peaceful and comfortable living space.

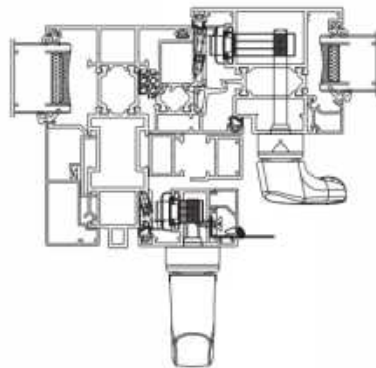
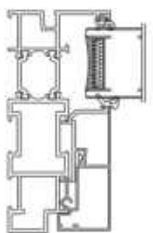
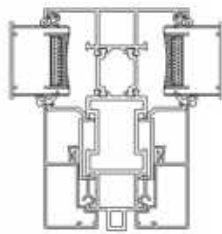
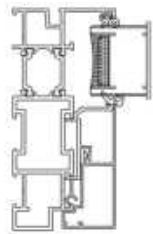
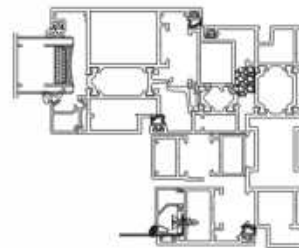
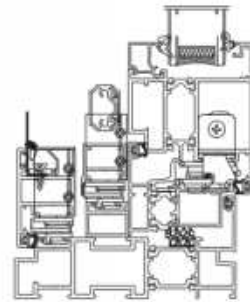
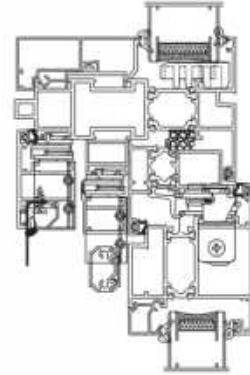
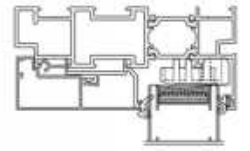
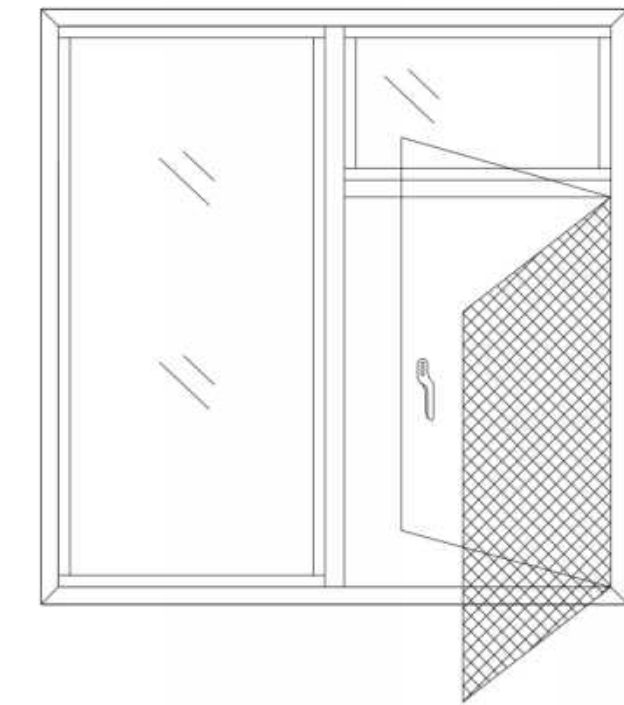

SHOWCASE GRAPH

# 728 SERIES

NON-THERMAL BREAK SLIDING WINDOW (CONSTRUCTION STYLE)

## Technical Parameters:

Frame thickness: 1.0mm

## Size rang:

Sash width 300mm-1200mm, Sash height 500mm-1300mm

## Glass specification:

5mm single layer clear tempered glass

## Product function:

Sliding window Two with gauze/four with gauze

## Product advantage:

1. Aeronautical grade aluminum profile, safe, stable and durable
2. High-end matte spraying process, scratch-resistant and wear-resistant.
3. Simple design, suitable for modern/luxury/minimalist decoration.
4. High-end hardware fittings, smooth and stable.

## PRODUCT ACCESSORIES



Handle Wheels

## HARDWARE CONFIGURATION

## HIGH-END SYSTEM DOORS AND WINDOWS

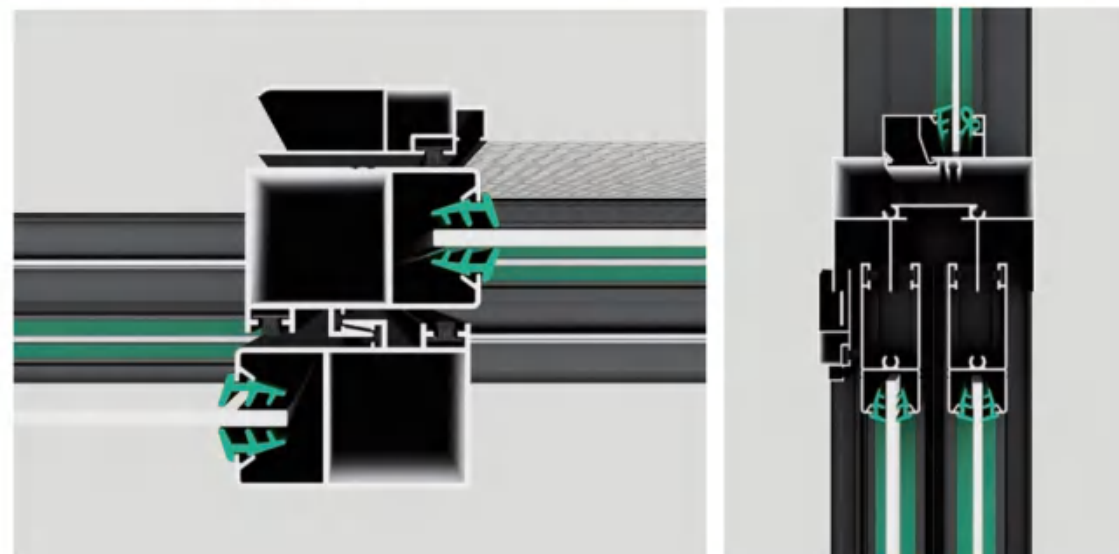

*Simplicity The minimalist design concept eliminates unnecessary decorations and creates a peaceful and comfortable living space.*

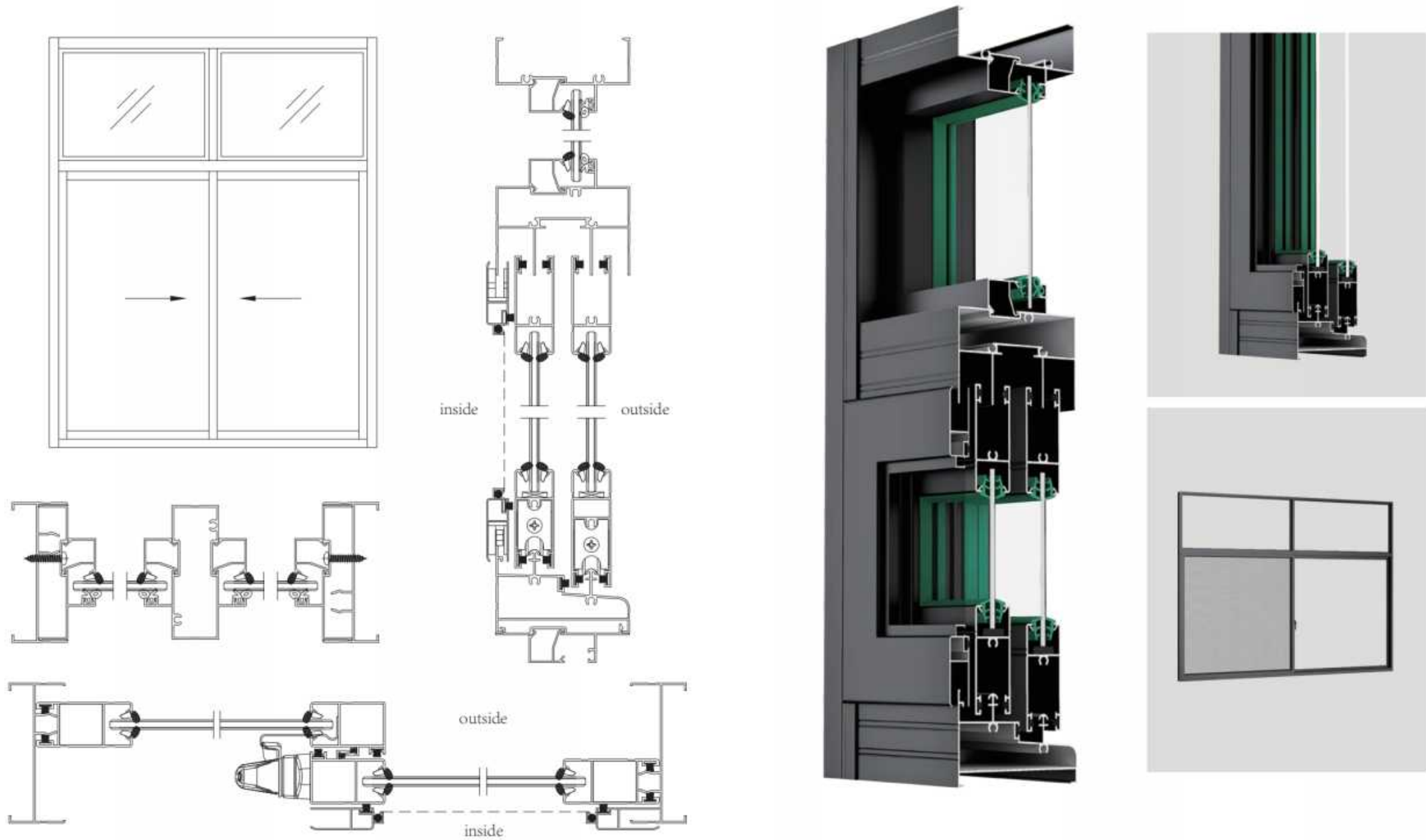

SHOWCASE GRAPH

# 90 SERIES

NON-THERMAL BREAK SLIDING WINDOW (CONSTRUCTION STYLE)

# HIGH-END SYSTEM DOORS AND WINDOWS

### Technical Parameters:

Frame thickness: 1.0mm

### Size rang:

Sash width 300mm-1200mm, Sash height 500mm-1300mm

### Glass specification:

5mm+9A+5mm double clear tempered glass

### Product function:

Sliding window Two with gauze/four with gauze

### Product advantage:

- 1、Aeronautical grade aluminum profile, safe, stable and durable
- 2、High-end matte spraying process, scratch-resistant and wear-resistant
- 3、Simple design, suitable for modern/luxury/minimalist decoration
- 4、High-end hardware fittings, smooth and stable



## PRODUCT ACCESSORIES



1-shaped Lock, Upper Wheels, Lock Block and Lock Set

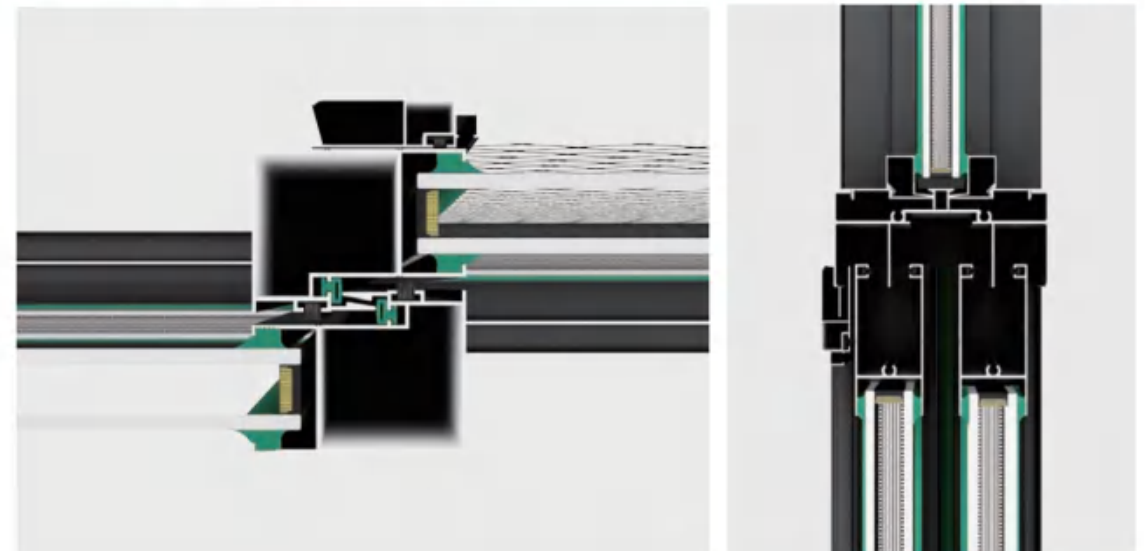

## HARDWARE CONFIGURATION

*Simplicity The minimalist design concept eliminates unnecessary decorations and creates a peaceful and comfortable living space.*

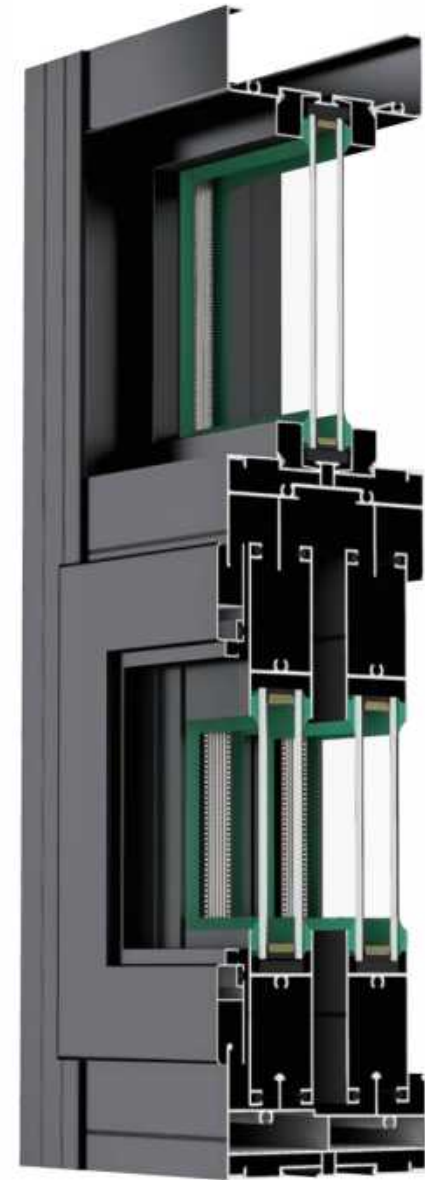
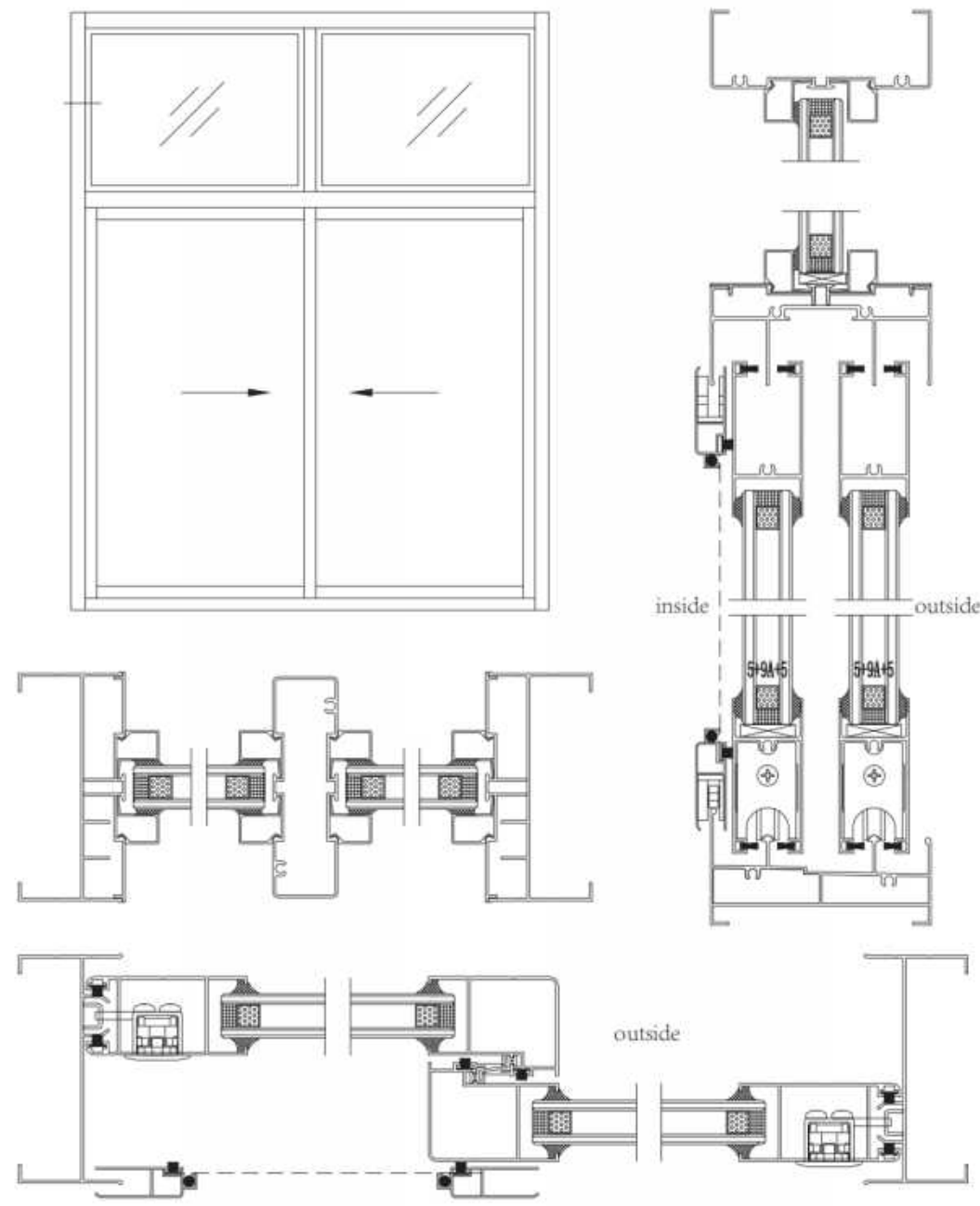

SHOWCASE GRAPH

# 80 SERIES

THERMAL BREAK SLIDING WINDOW (2 TRACKS)

# HIGH-END SYSTEM DOORS AND WINDOWS

### Technical Parameters:

Frame thickness: 1.8mm

### Size rang:

Sash width 300mm-2000mm, Sash height 800mm-1800mm

### Glass specification:

5mm+15A+5mm double clear tempered glass

### Heat insulation strip:

14.8mm

### Product function:

Sliding window Two/four

### Product advantage:

1. Doesn't take up indoor space, large pushing and pulling area, good ventilation and air permeability
2. High-end slide structure, stable and smooth
3. Two-track design with high-precision screen, better anti-mosquito effect.
4. Multi-scene adaptation, excellent practical function.

## PRODUCT ACCESSORIES



Lower Wheels, Typhoon wheels, Lock Block and Lock Set, \*1"Shaped Lock

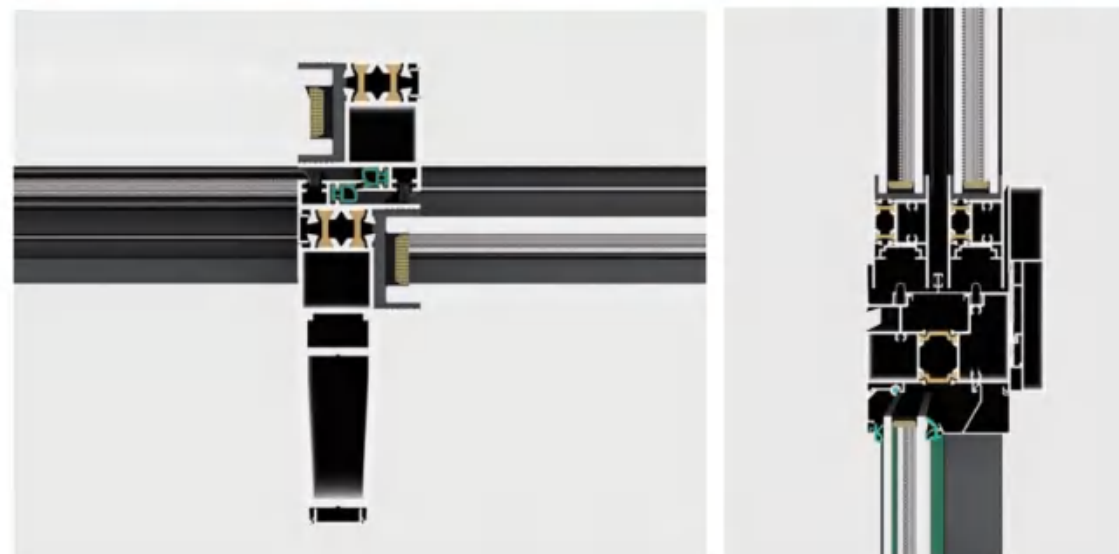

## HARDWARE CONFIGURATION

*Simplicity The minimalist design concept eliminates unnecessary decorations and creates a peaceful and comfortable living space.*

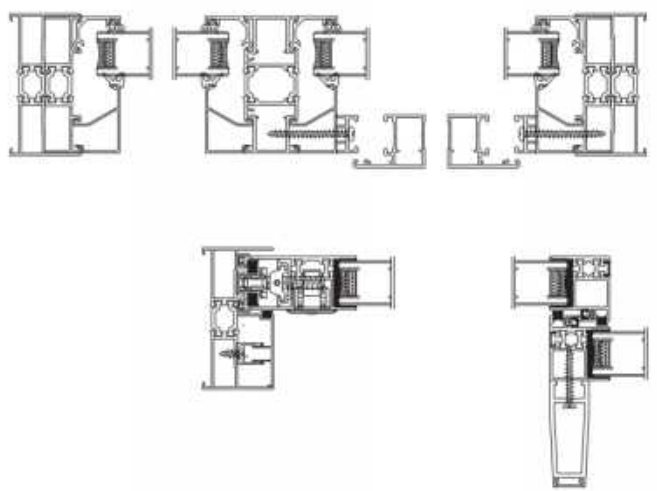
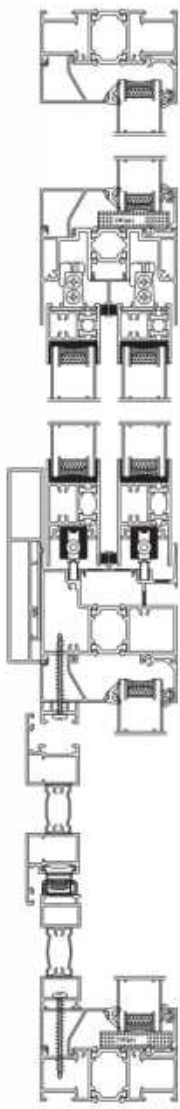
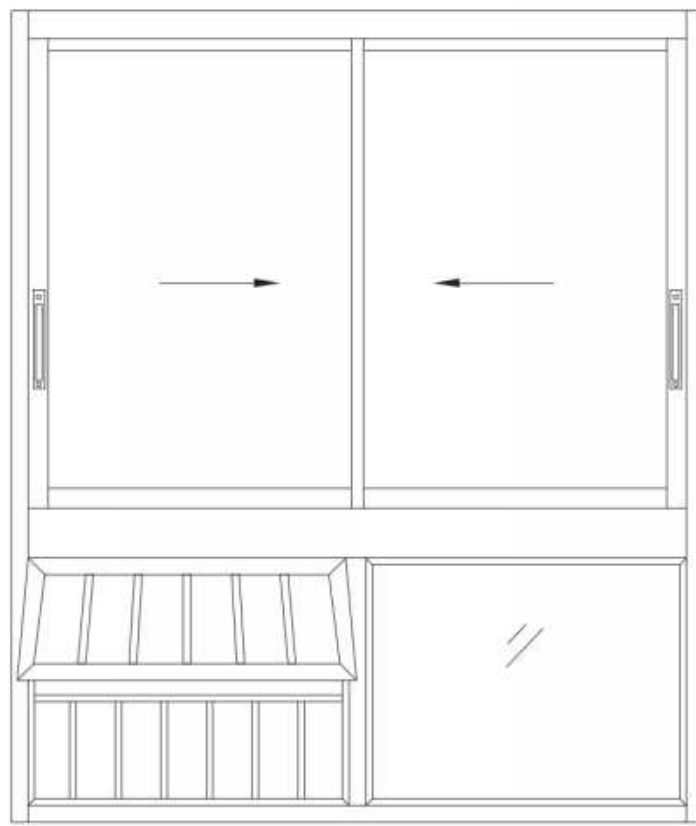

SHOWCASE GRAPH

# 120 SERIE

THERMAL BREAK SLIDING WINDOW (3 TRACKS)

## HIGH-END SYSTEM DOORS AND WINDOWS

### Technical Parameters:

Frame thickness: 1.8mm

### Size rang:

Sash width 300mm-2000mm, Sash height 800mm-1800mm

### Glass specification:

5mm+15A+5mm double clear tempered glass

### Heat insulation strip:

14.8mm

### Product function:

Sliding window Three-track two-panel with gauze/Three-track three-panel/three-track four-panel with gauze/three-track six-panel

### Product advantage:

1. Adopting high-strength and high-quality aluminum alloy material structure design, is sturdy and durable
2. It can broadens views and enhances lightness
3. Parallel track sliding method not only reduces the friction impact of the window sash, but also makes safe and stable
4. Bridge cut-off technology reduces heat conduction and provides excellent thermal and sound insulation

### PRODUCT ACCESSORIES



Lower Wheels, Typhoon wheels, Lock Block and Lock Set, "1" Shaped Lock

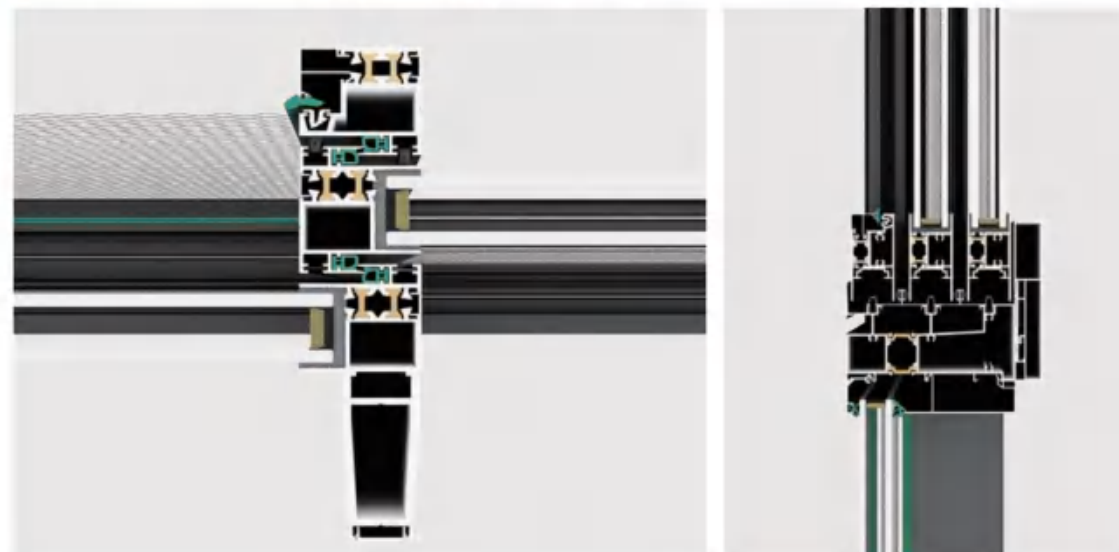

*Simplicity The minimalist design concept eliminates unnecessary decorations and creates a peaceful and comfortable living space.*

HARDWARE CONFIGURATION

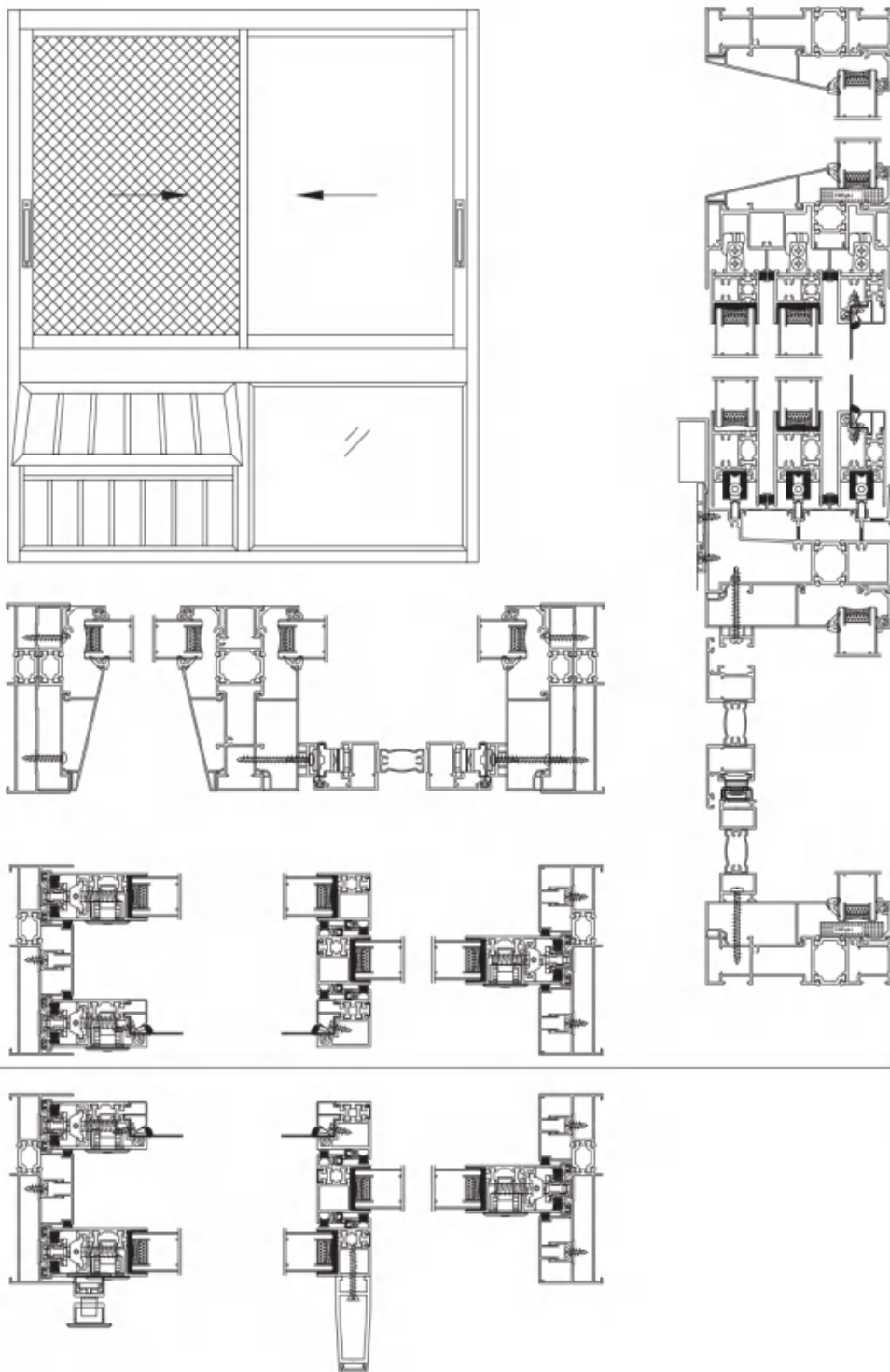

SHOWCASE GRAPH

# 88 SERIE

HERMAL BREAK SLIDING WINDOW(2 TRACKS)

# HIGH-END SYSTEM DOORS AND WINDOWS

### Technical Parameters:

Frame thickness: 1.4mm

### Size rang:

Sash width 750mm-2500mm, Sash height 800mm-1300mm

### Glass specification:

5mm+15A+5mm double clear tempered glass

### Heat insulation strip:

14.8mm

### Product function:

Sliding window Two/four

### Product advantage:

- 1、 It doesn't take up much room space, has a large push-pull area, and is well-ventilated
- 2、 Fixed below can be equipped with handrails to create a scenic recreational area
- 3、 304 stainless steel diamond mesh which is Triple-rail design, applicable to a longer life, and anti-mosquito effect is remarkable.
- 4、 The embedded design of the downward track effectively prevents the wind and rain from disturbing and improves the sealing performance of the doors and windows.



## PRODUCT ACCESSORIES



Lower Wheels, Typhoon wheels, Lock Block and Lock Set, \*1"Shaped Lock

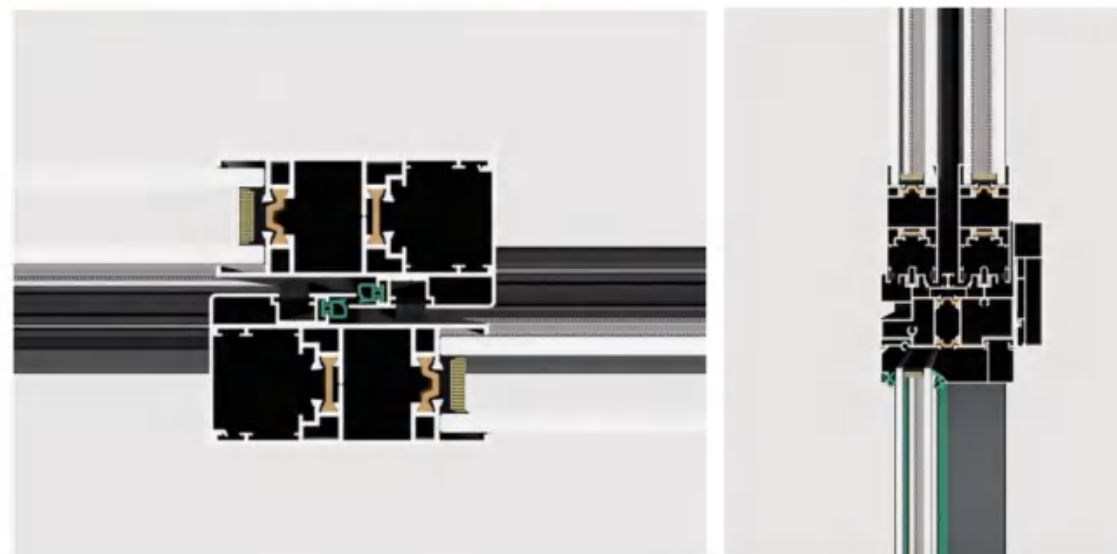

## HARDWARE CONFIGURATION

*Simplicity The minimalist design concept eliminates unnecessary decorations and creates a peaceful and comfortable living space.*

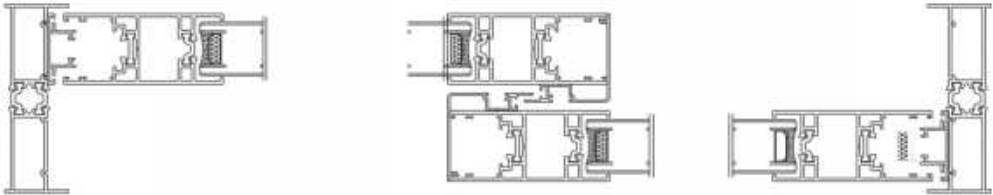
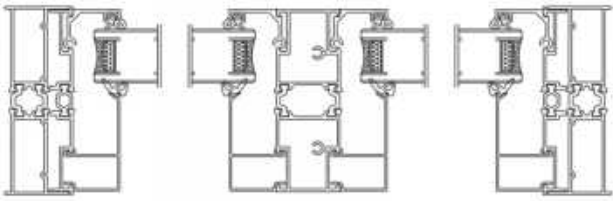
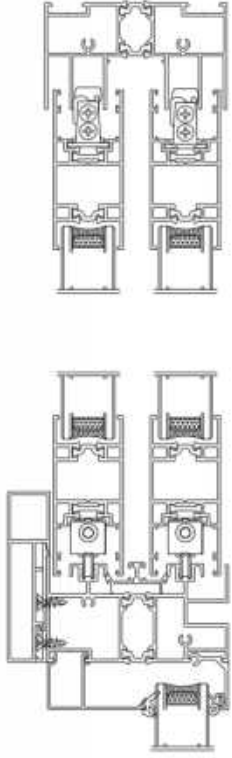
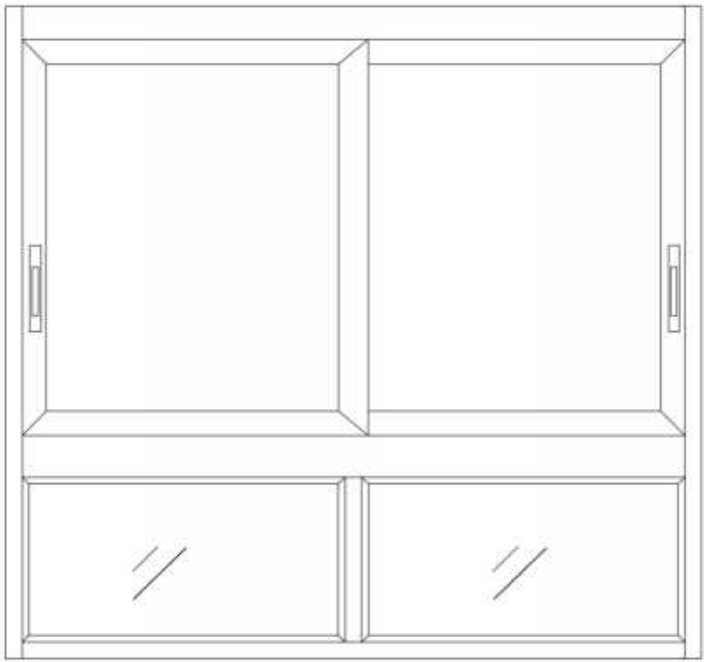

SHOWCASE GRAPH

# 135 SERIES

THERMAL BREAK SLIDING WINDOW(3 TRACKS)

## HIGH-END SYSTEM DOORS AND WINDOWS

### Technical Parameters:

Frame thickness: 1.4mm

### Size rang:

Sash width 450mm-1000mm, Sash height 1000mm-2400mm

### Glass specification:

5mm+15A+5mm double clear tempered glass

### Heat insulation strip:

14.8mm

### Product function:

Sliding window Three-track two-panel with gauze/Three-track three-panel/three-track four-panel with gauze/three-track six-panel

### Product advantage:

1. Bridge cut-off sliding door has better thermal insulation performance
2. Adopting stainless steel shaft and carbon fiber pulleys, pushing and pulling for 100,000 times is not a problem, sliding smoothly and durably
3. High-rail track design for effective waterproofing
4. Hollow glass which is 5+15A+5, has better sound insulation performance

### PRODUCT ACCESSORIES



Lower Wheels, Typhoon wheels, Lock Block and Lock Set, \*1\*Shaped Lock

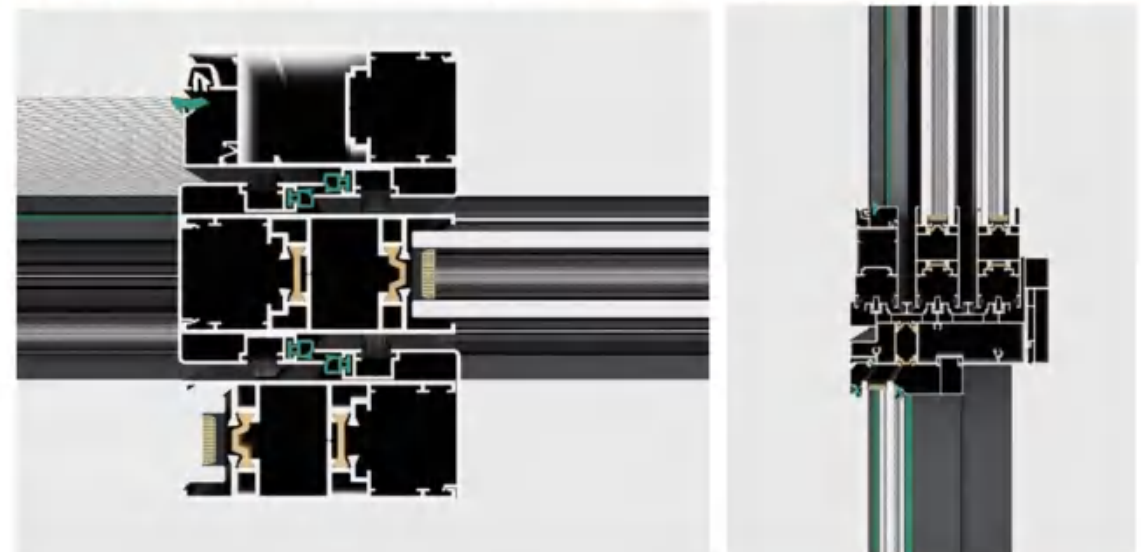

*Simplicity The minimalist design concept eliminates unnecessary decorations and creates a peaceful and comfortable living space.*

HARDWARE CONFIGURATION

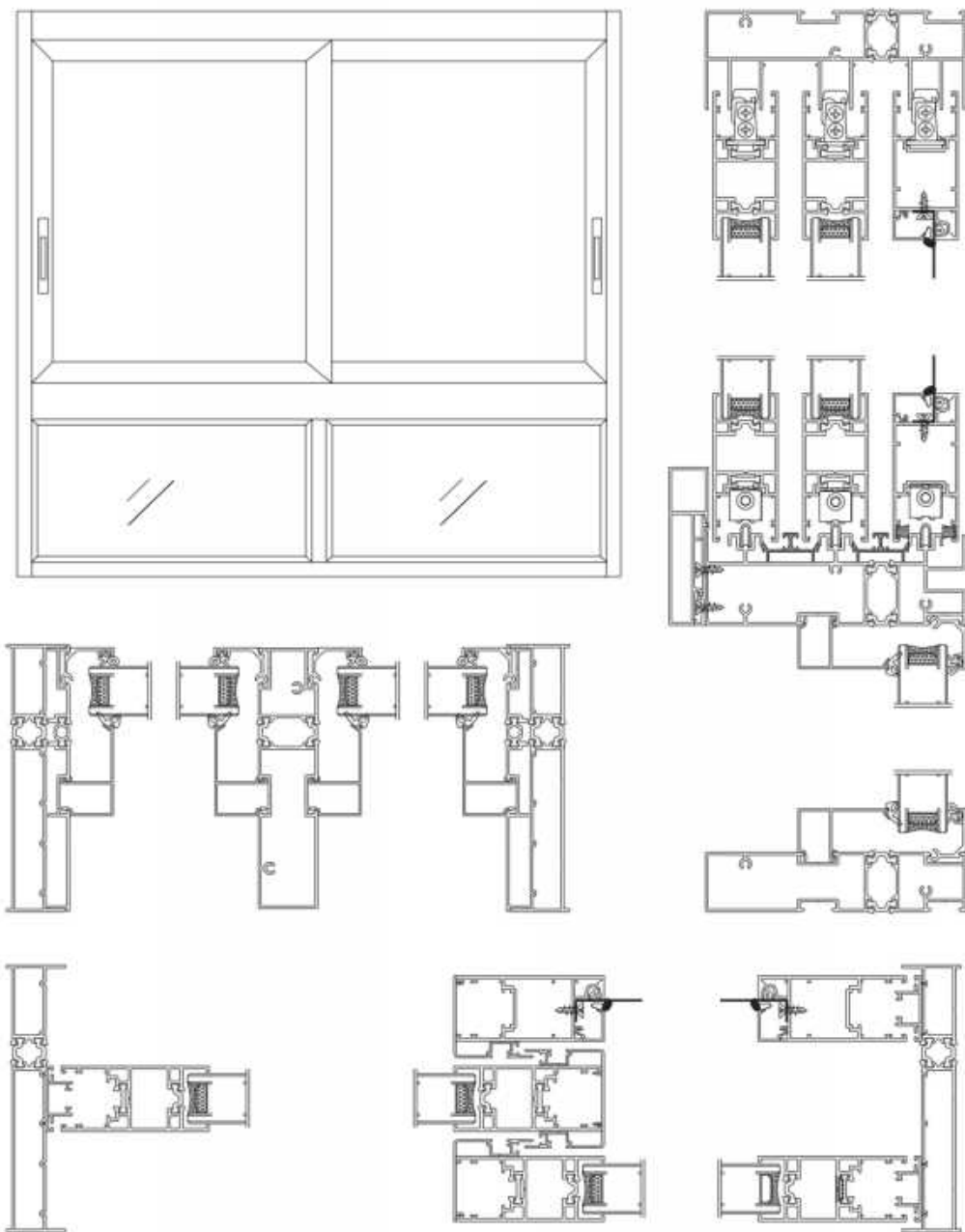

SHOWCASE GRAPH

# 120 SERIE

NON-THERMAL BREAK SLIDING WINDOW(3 TRACKS)

## HIGH-END SYSTEM DOORS AND WINDOWS

### Technical Parameters:

Frame thickness: 1.2mm

### Size rang:

Sash width 500mm-1400mm, Sash height 800mm-1400mm

### Glass specification:

5mm+15A+5mm double clear tempered glass

### Product function:

Sliding window Three-track two-panel with gauze/Three-track three-panel/three-track four-panel with gauze/three-track six-panel

### Product advantage:

- 1、 High quality pulley system, quiet and smooth pushing and pulling
- 2、 thickened profile design, to ensure the strength of the frame stable
- 3、 large area lighting design, wide vision
- 4、 suitable for balcony, kitchen, living room partition and other occasions



## PRODUCT ACCESSORIES



\*1"Shaped Lock , Upper and Lower Wheels , Lock Block and Lock Set

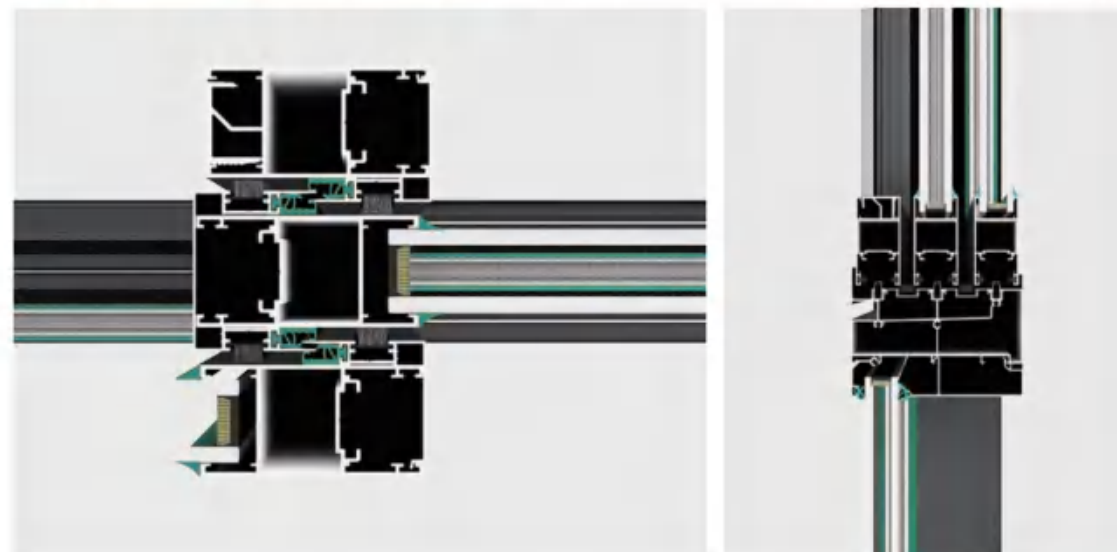

## HARDWARE CONFIGURATION

*Simplicity The minimalist design concept eliminates unnecessary decorations and creates a peaceful and comfortable living space.*

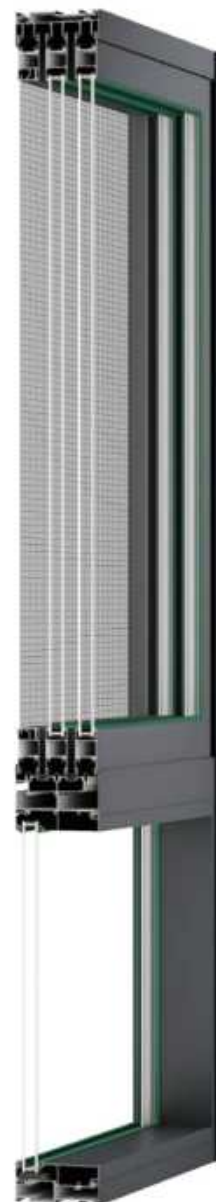
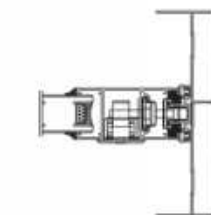
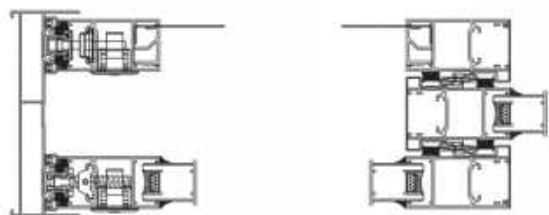
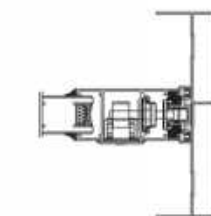
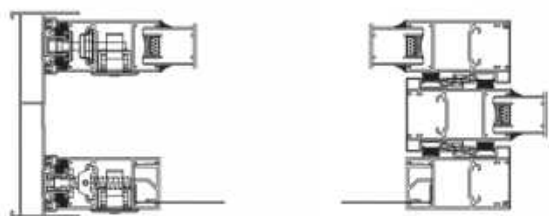
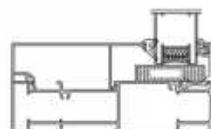
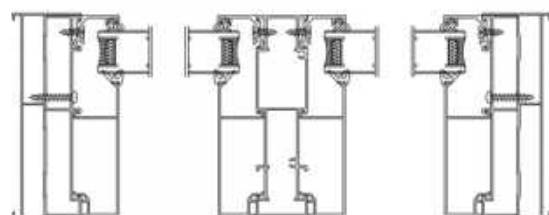
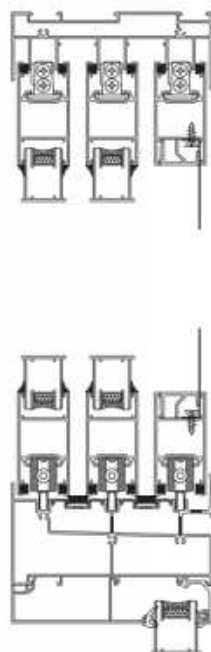
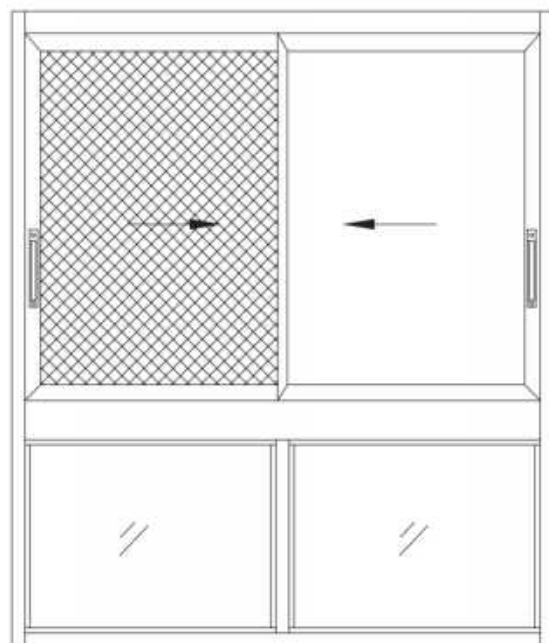

SHOWCASE GRAPH

# 80 SERIE

NON-THERMAL BREAK SLIDING WINDOW(2 TRACKS)

## HIGH-END SYSTEM DOORS AND WINDOWS

### Technical Parameters:

Frame thickness: 1.2mm

### Size rang:

Sash width 500mm-1400mm, Sash height 800mm-1400mm

### Glass specification:

5mm+15A+5mm double clear tempered glass

### Product function:

Sliding window Two tracks and two fans/Two tracks and four fans Three tracks with two panels and gauze/hree tracks with three panels /Three tracks with four panels and gauze/three tracks with six panels

### Product advantage:

- 1、 Doesn't take up indoor space, large pushing and pulling area, good ventilation and air permeability
- 2、 High-end slide structure, stable and smooth
- 3、 Two-track design with high-precision screen, better anti-mosquito effect.
- 4、 Multi-scene adaptation, excellent practical function.



### PRODUCT ACCESSORIES



\*1"Shaped Lock , Upper and Lower Wheels , Lock Block and Lock Set

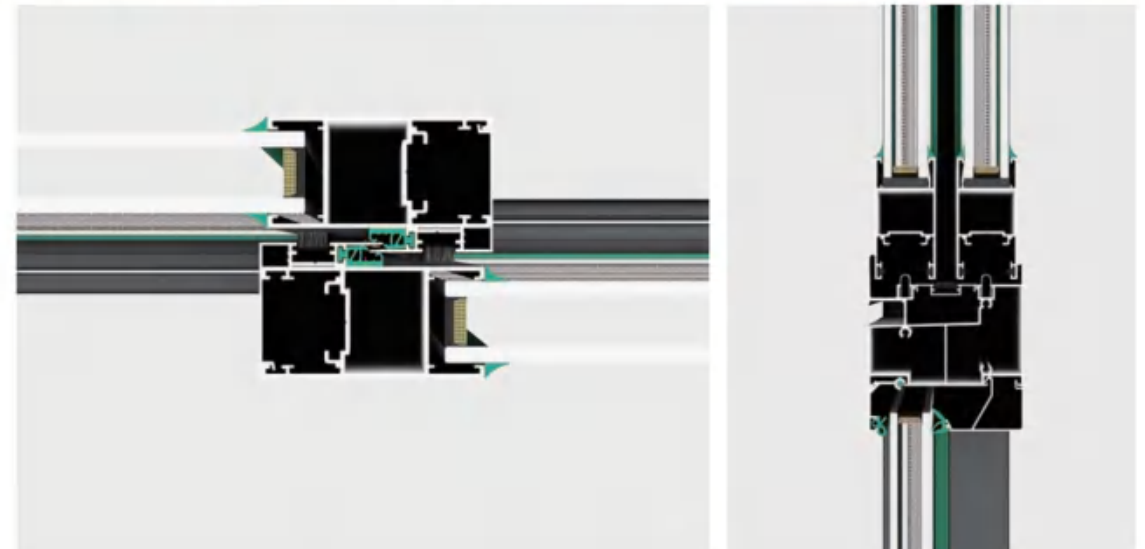

## HARDWARE CONFIGURATION

*Simplicity The minimalist design concept eliminates unnecessary decorations and creates a peaceful and comfortable living space.*

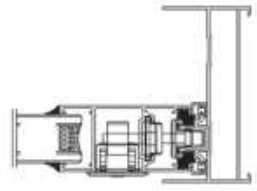
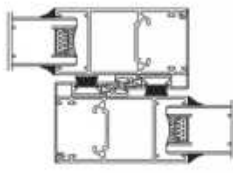
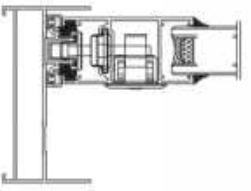
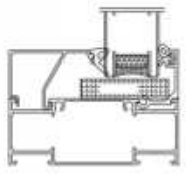
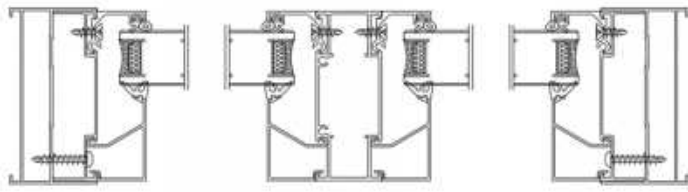
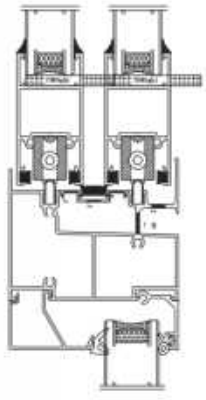
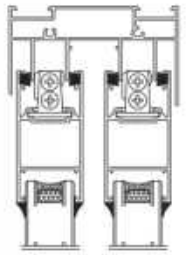

SHOWCASE GRAPH

# 90-137 SERIES

NON-THERMAL BREAK SLIDING DOOR(3 TRACKS)

## HIGH-END SYSTEM DOORS AND WINDOWS

### Technical Parameters:

Frame thickness:2.0mm

### Size rang:

Sash width 500mm-1500mm, Sash height 800mm-2500mm

### Glass specification:

5mm+15A+5mm double clear tempered glass

### Product function:

Sliding door Two tracks and two fans/Two tracks and four fans Three tracks with two panels and gauze/Three tracks with three panels /Three tracks with four panels and gauze/three tracks with six panels

### Product advantage:

- 1、 Doesn't take up indoor space, large pushing and pulling area, good ventilation and air permeability
- 2、 High-end slide structure, stable and smooth
- 3、 Two-track design with high-precision screen, better anti-mosquito effect
- 4、 Multi-scene adaptation, excellent practical function

### PRODUCT ACCESSORIES



Upper Wheels



"1"Shaped Lock, Lower Wheels

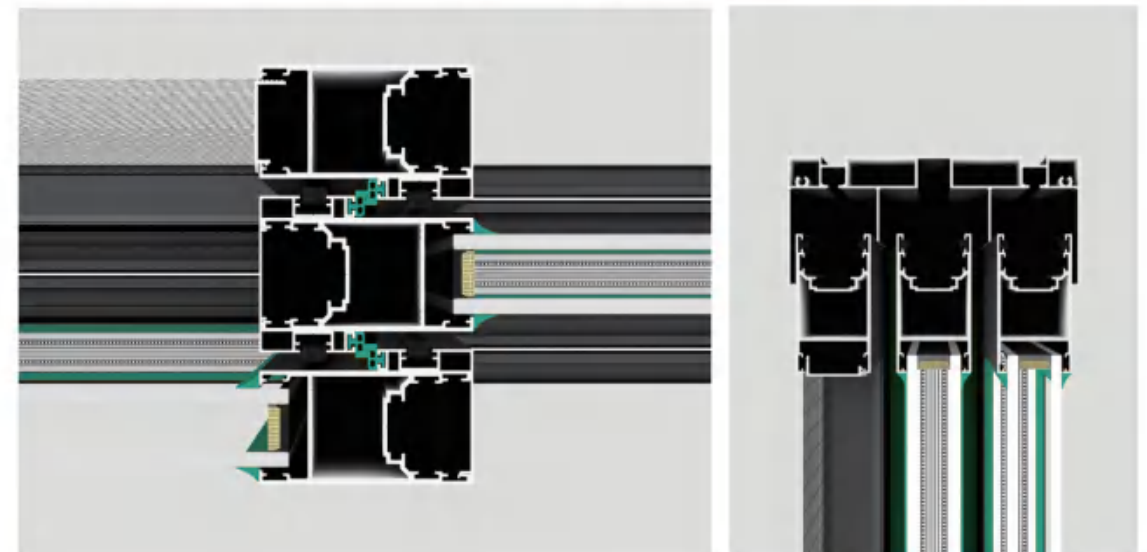

## HARDWARE CONFIGURATION

Simplicity The minimalist design concept eliminates unnecessary decorations and creates a peaceful and comfortable living space.

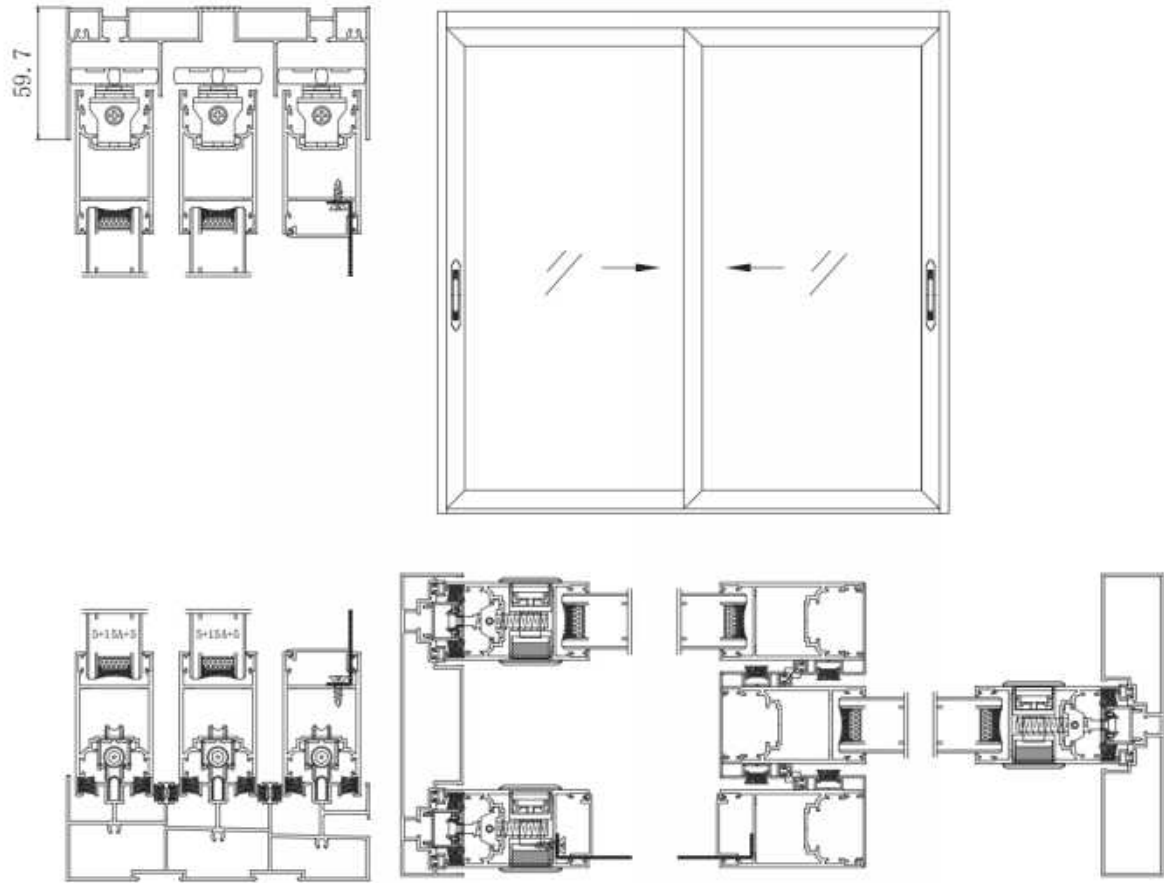

SHOWCASE GRAPH

# 4535 SERIES

NON-THERMAL BREAK SLIDING DOOR

## HIGH-END SYSTEM DOORS AND WINDOWS

### Technical Parameters:

Frame thickness: 1.4mm

### Size rang:

Sash width 500mm-1500mm, Sash height 800mm-2500mm

### Glass specification:

4mm+15A+4mm double clear tempered glass

### Product function:

Sliding door Two screens with gauze/Three screens/four screens/four screens with gauze/six screens

### Product advantage:

1. The product appearance design is fashionable and simple, outstanding value
2. Adopting stainless steel axis, carbon fiber pulley, push and pull 100,000 times without failure
3. Medium and narrow design, the sense of the times and stability highlights the low-profile
4. Can be made of lattice strips, craft glass and other styles with home style



### PRODUCT ACCESSORIES



1-shaped Lock, Upper Wheels, Lock Block and Lock Set

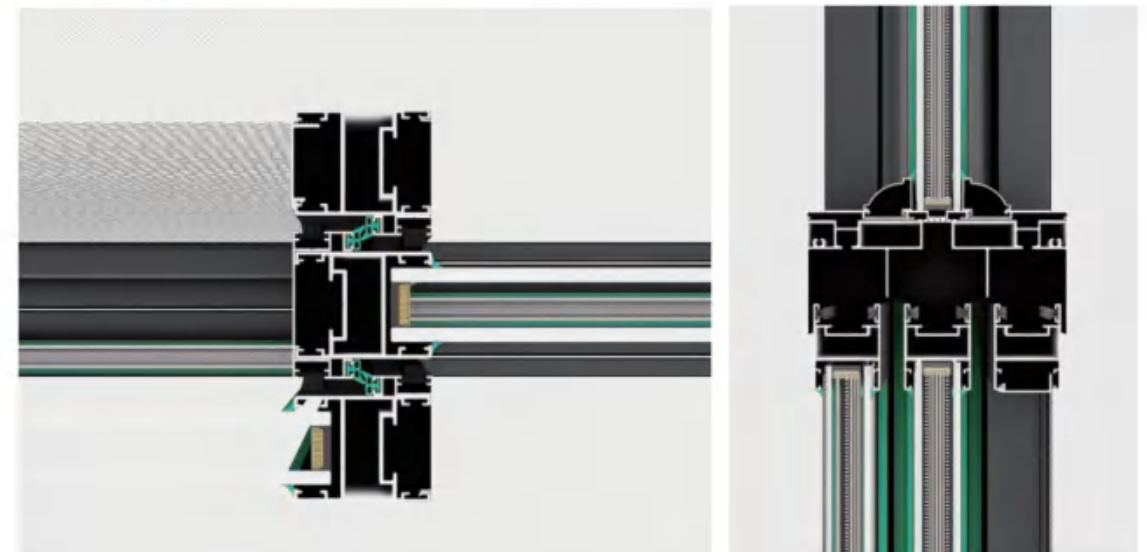

## HARDWARE CONFIGURATION

*Simplicity The minimalist design concept eliminates unnecessary decorations and creates a peaceful and comfortable living space.*

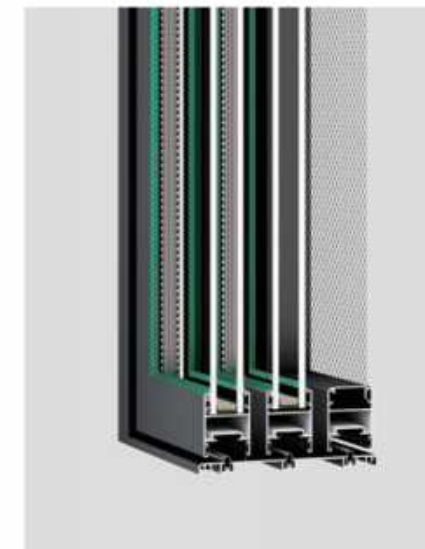
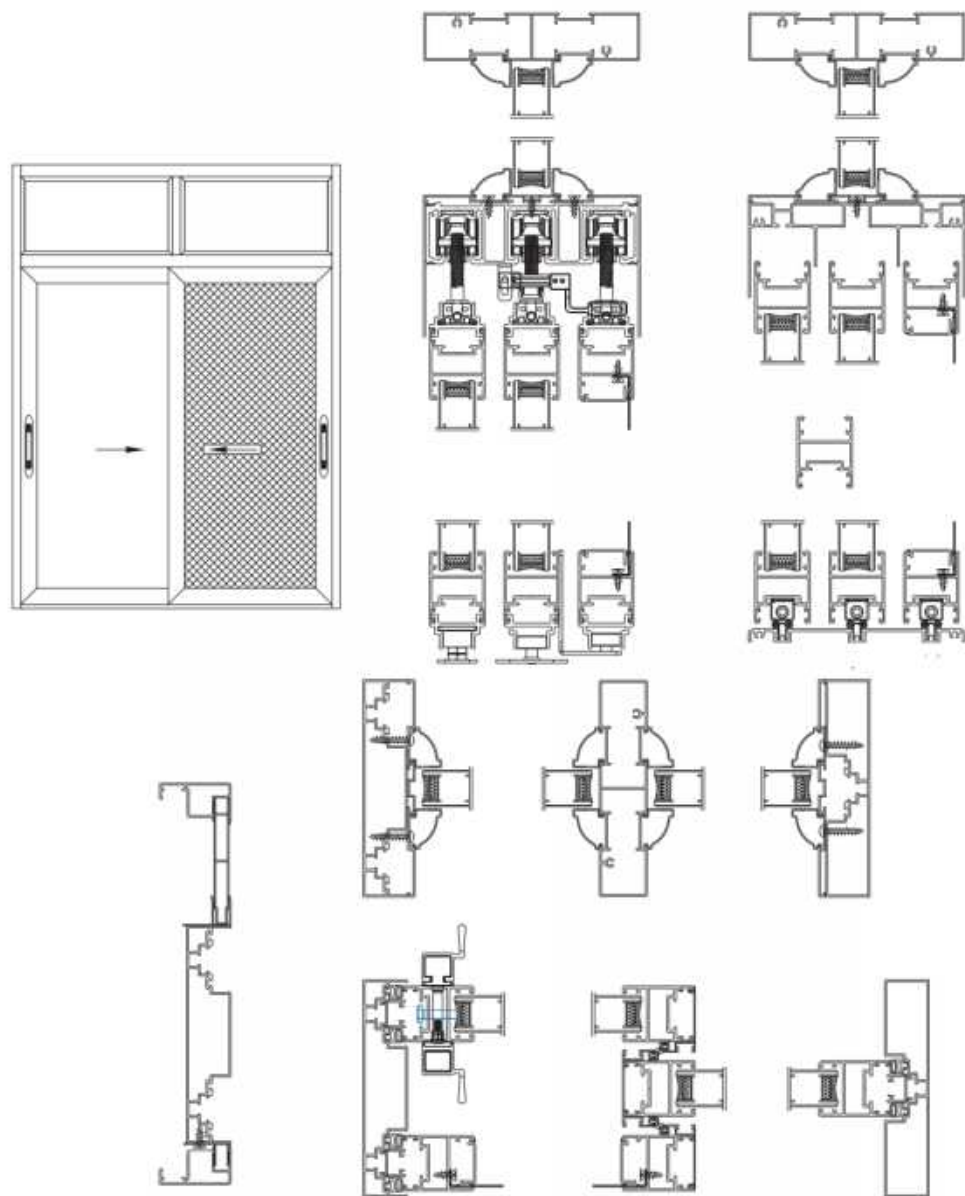

SHOWCASE GRAPH

# 180-65 SERIES

NON-THERMAL BREAK SLIDING DOOR

## HIGH-END SYSTEM DOORS AND WINDOWS

### Technical Parameters:

Frame thickness: 1.4mm

### Size rang:

Sash width 500mm-2000mm, Sash height 1000mm-3000mm

### Glass specification:

5mm+15A+5mm double clear tempered glass

### Product function:

Sliding door Two tracks and two fans/Two tracks and four fans Three tracks with two panels and gauze/Three tracks with three panels /Three tracks with four panels and gauze/three tracks with six panels

### Product advantage:

- 1、Elegant and generous product appearance, outstanding value
- 2、Embedded structure design, airtightness and watertightness is better
- 3、Smooth frame and fan surface, fresh and elegant, cost-effective
- 4、Simple and fashionable, medium and narrow design, perfect combination with modern light luxury style



## PRODUCT ACCESSORIES



Lower Wheels

1"Shaped Lock, Upper Wheels,  
Lock Block and Lock Set

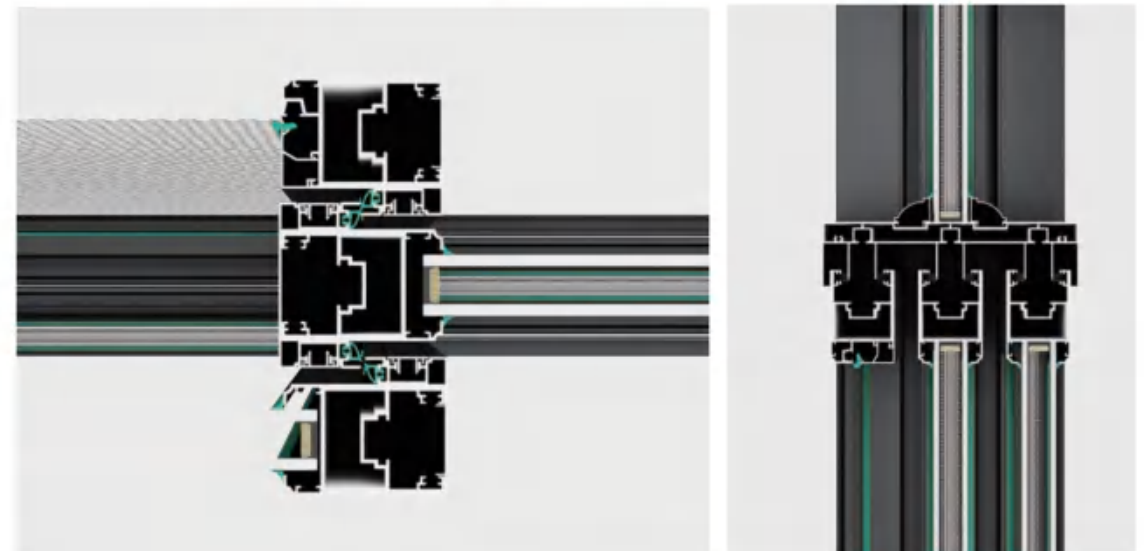

## HARDWARE CONFIGURATION

*Simplicity The minimalist design concept eliminates unnecessary decorations and creates a peaceful and comfortable living space.*

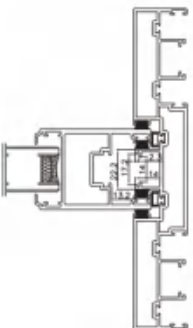
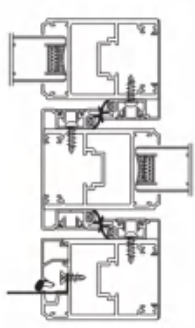
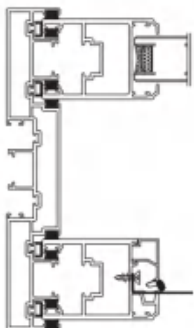
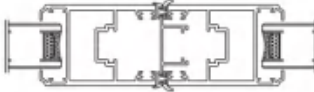
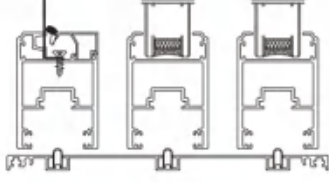
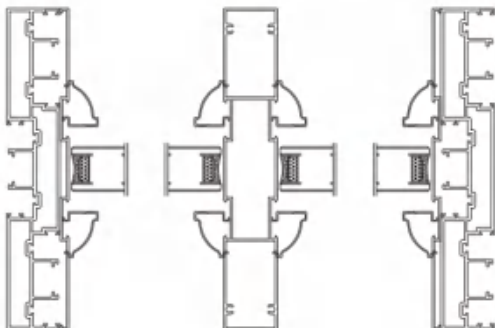
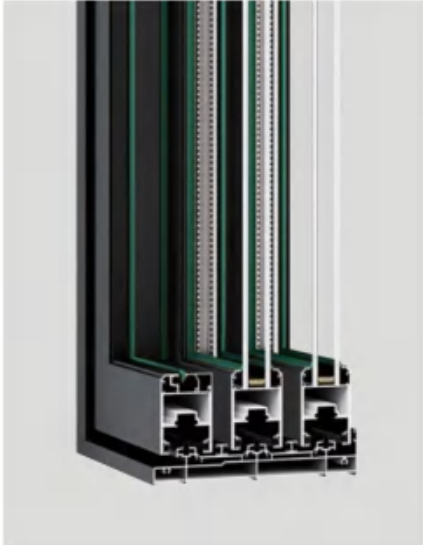
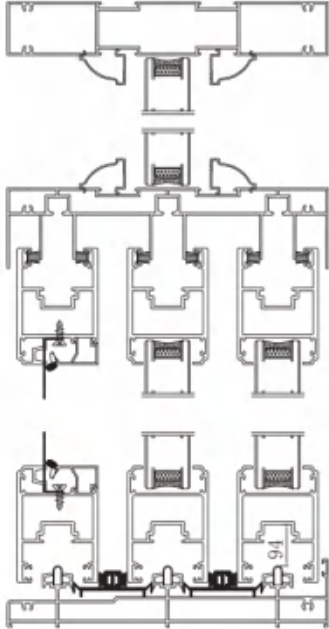
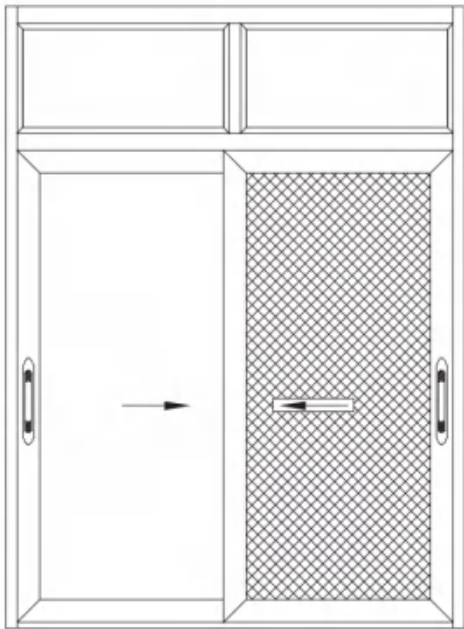

SHOWCASE GRAPH

# 120-190 SERIE

THERMAL BREAK LIFT AND SLIDING DOOR

# HIGH-END SYSTEM DOORS AND WINDOWS

### Technical Parameters:

Frame thickness: 2.3mm

### Size rang:

Sash width 500mm-2000mm, Sash height 1000mm-3000mm

### Glass specification:

5mm+27A+5mm double clear tempered glass

### Product function:

Sliding door Two tracks and two fans/Two tracks and four fans Three tracks with two panels and gauze/Three tracks with three panels /Three tracks with four panels and gauze/three tracks with six panels

### Product advantage:

1. 2.3mm profile thickness, higher safety performance and wind pressure resistance;
2. Gluing process, enhance the frame solid performance and splicing strength;
3. High-rail floor drain design, more conducive to the evacuation of rainwater, beautiful and practical;
4. Folding hidden yarn, the use of encrypted mesh yarn production, environmental health, full toughness;



## PRODUCT ACCESSORIES



Normal Sliding Door -Lower Wheels\ Upper Wheels\ Lock Block and Lock Set



\*1" Shaped Lock For Normal Sliding Door/Lifting Handle



Connector For Lifting Wheels



Transmission Rod For Lifting Lock Body



Transmission Rod For Lifting Lock Body2

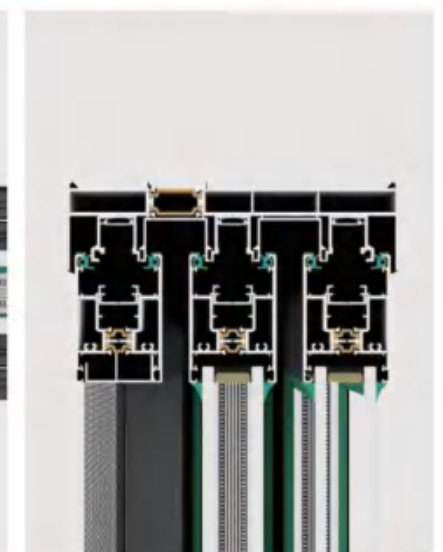
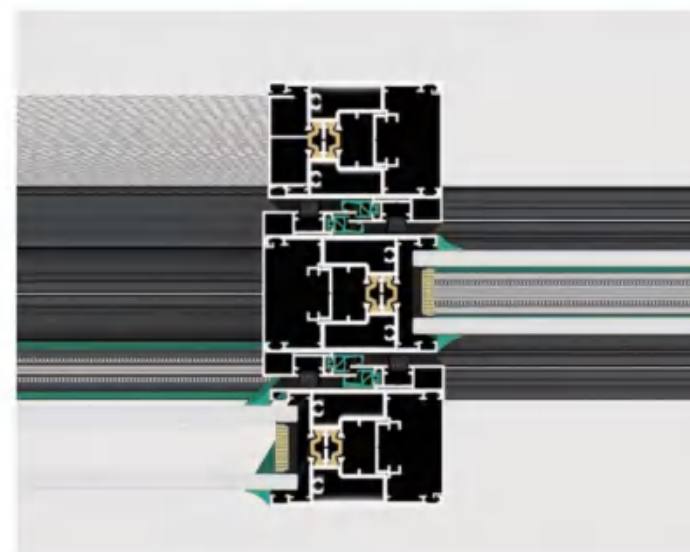

## HARDWARE CONFIGURATION

Simplicity The minimalist design concept eliminates unnecessary decorations and creates a peaceful and comfortable living space.

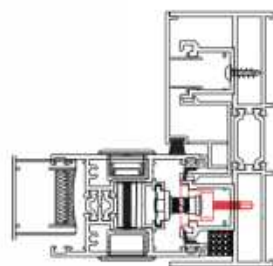
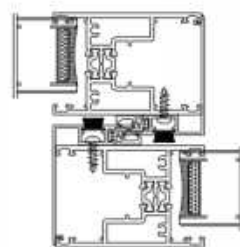
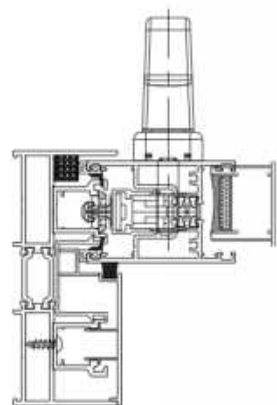
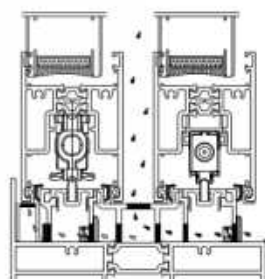
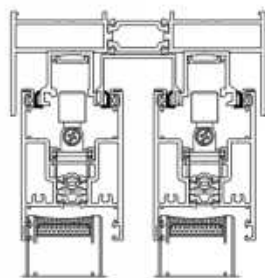
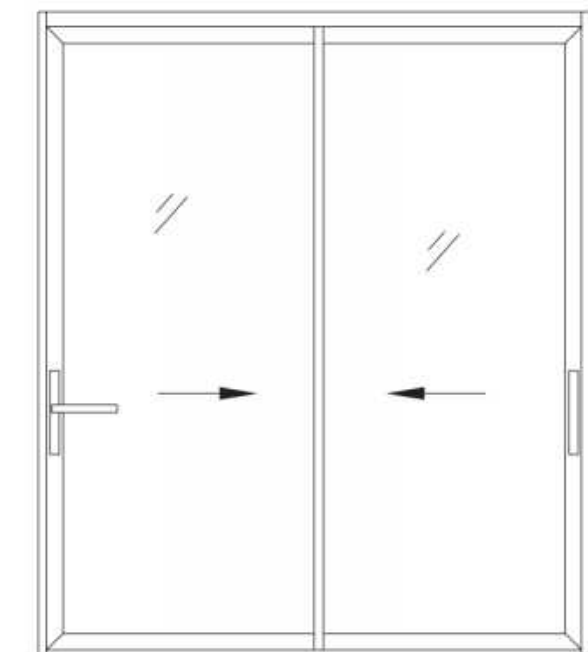

SHOWCASE GRAPH

# 80-120 SERIE

SERIES NON-THERMAL BREAK SLIDING DOOR

# HIGH-END SYSTEM DOORS AND WINDOWS

### Technical Parameters:

Frame thickness: 1.2mm

### Size rang:

Sash width 500mm-1400mm, Sash height 800mm-2200mm

### Glass specification:

5mm+12A+5mm double clear tempered glass

### Product function:

Sliding door Two tracks and two fans/Two tracks and four fans Three tracks with two panels and gauze/Three tracks with three panels /Three tracks with four panels and gauze/three tracks with six panels

### Product advantage:

1. Doesn't take up indoor space, large pushing and pulling area, good ventilation and air permeability
2. High-end slide structure, stable and smooth
3. Match with high precision screen, better anti-mosquito effect
4. Multi-scene adaptable, excellent practical function

## PRODUCT ACCESSORIES



\*1"Shaped Lock\Lower Wheels\  
Upper Wheels\Lock Block and Lock Set

Lock Rod

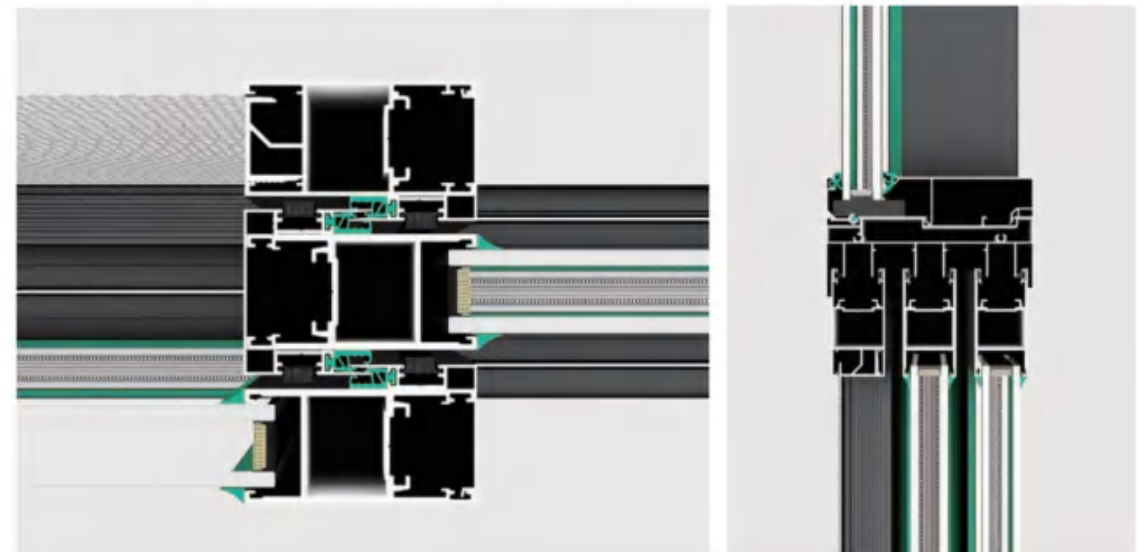

## HARDWARE CONFIGURATION

*Simplicity The minimalist design concept eliminates unnecessary decorations and creates a peaceful and comfortable living space.*

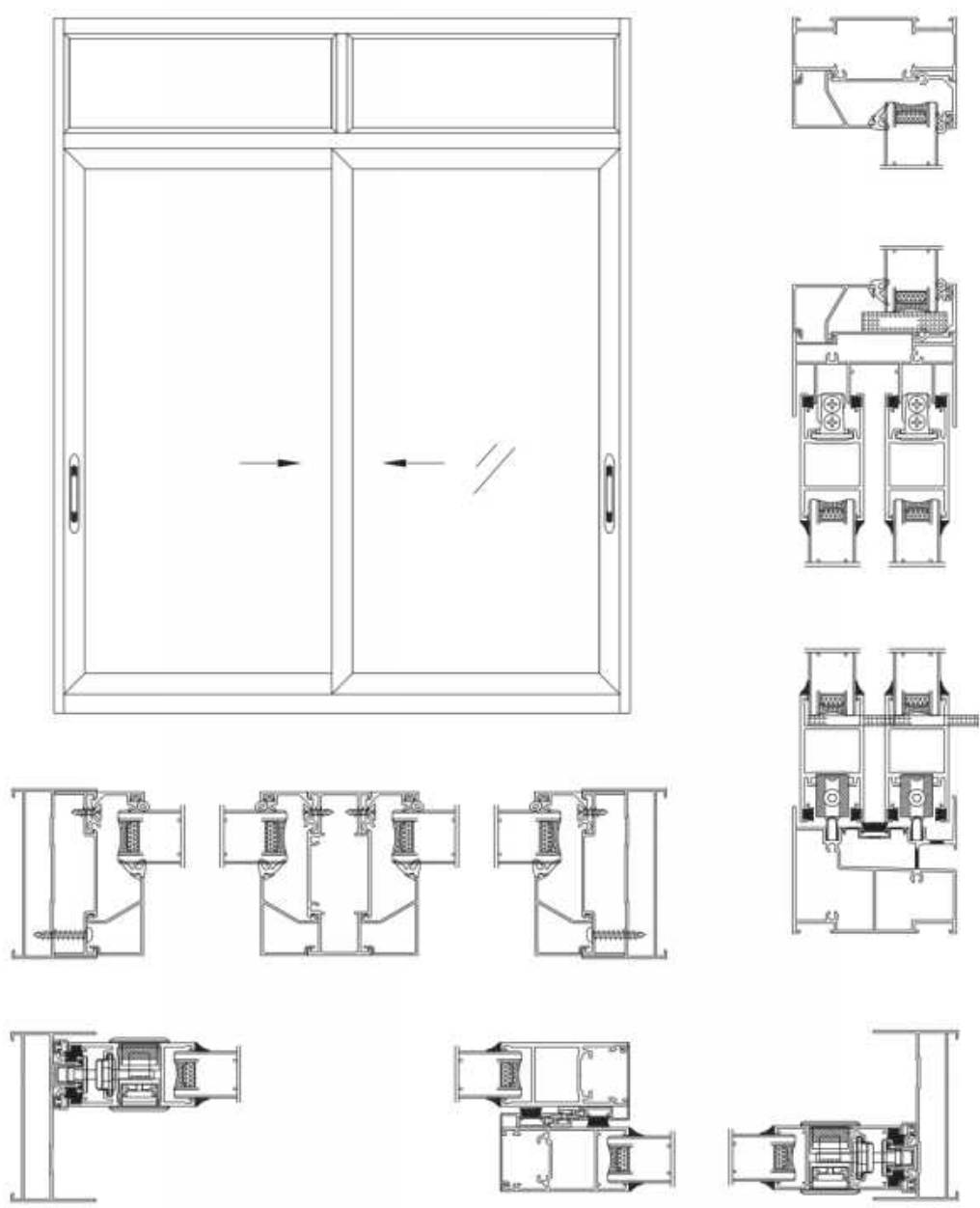

SHOWCASE GRAPH

# 88-135 SERIES

THERMAL BREAK SLIDING DOOR(2 TRACKS)

## HIGH-END SYSTEM DOORS AND WINDOWS

### Technical Parameters:

Frame thickness:2.0mm

### Size rang:

Sash width 500mm-1400mm, Sash height 800mm-2500mm

### Glass specification:

5mm+15A+5mm double clear tempered glass

### Product function:

Sliding door Two tracks and two fans/Two tracks and four fans Three tracks with two panels and gauze/Three tracks with three panels /Three tracks with four panels and gauze/three tracks with six panels

### Product advantage:

- 1、 Doesn't take up indoor space, large pushing and pulling area, good ventilation and air permeability
- 2、 High-end slide structure, stable and smooth
- 3、 Match with high precision screen, better anti-mosquito effect
- 4、 Multi-scene adaptable, excellent practical function



### PRODUCT ACCESSORIES



\*1"Shaped Lock\Lower Wheels\  
Upper Wheels\Lock Block and Lock Set



Lock Rod

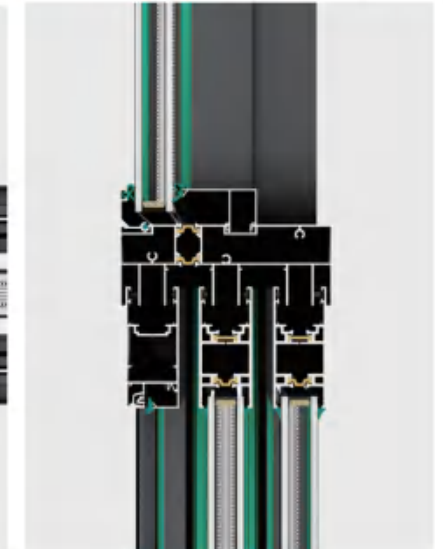
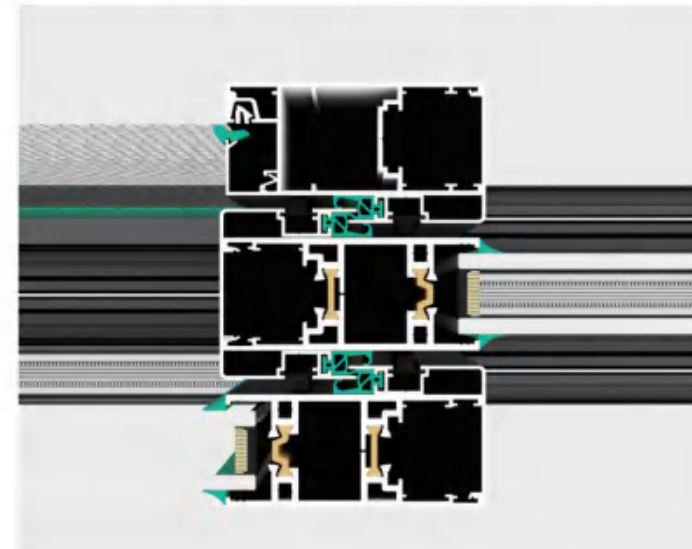

## HARDWARE CONFIGURATION

*Simplicity The minimalist design concept eliminates unnecessary decorations and creates a peaceful and comfortable living space.*

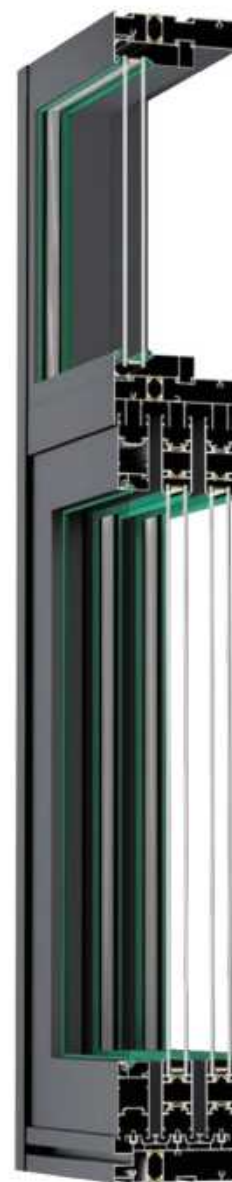
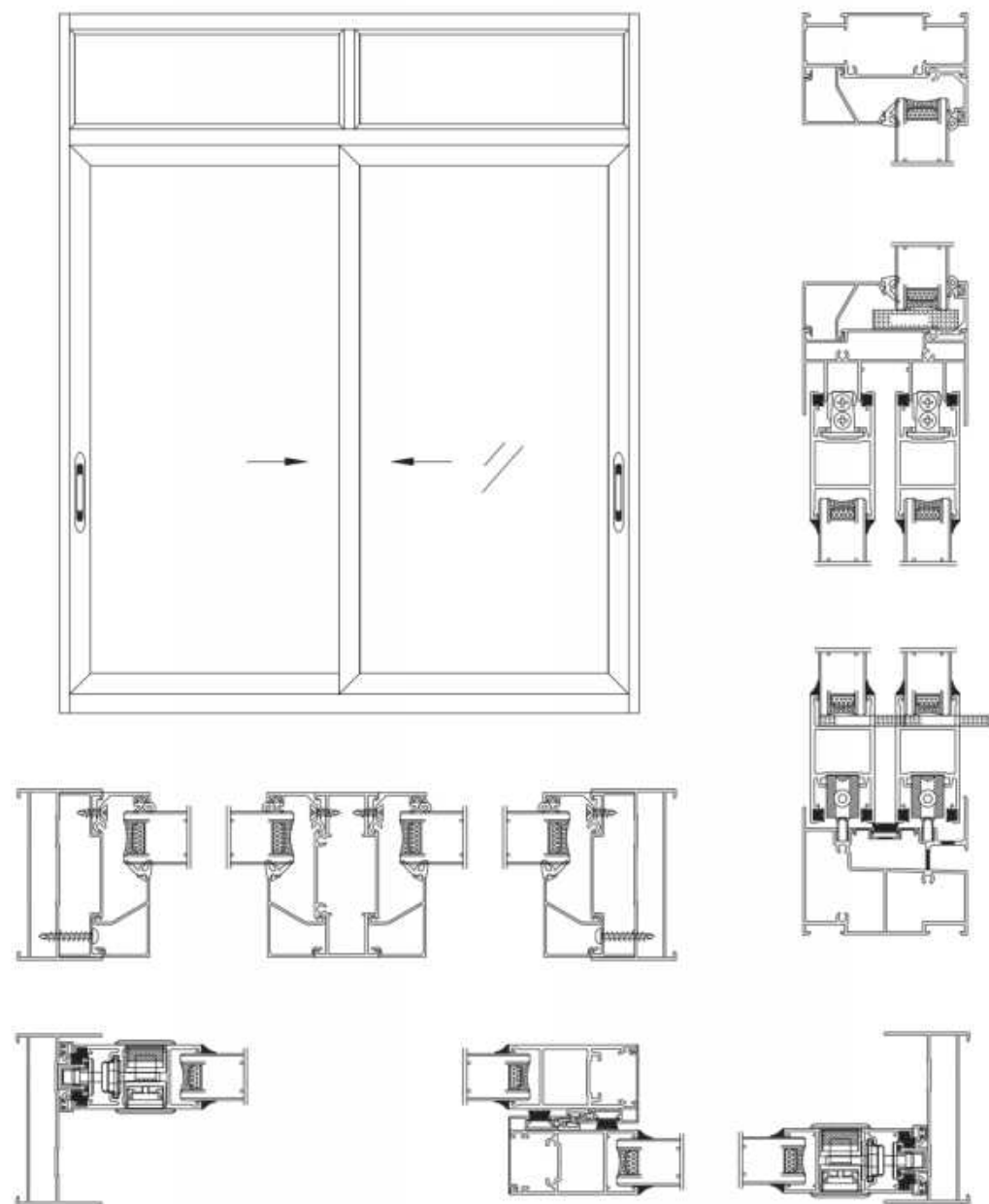

SHOWCASE GRAPH

# 85 SERIES

THERMAL BREAK HIDE HINGE FOLDING DOOR

# HIGH-END SYSTEM DOORS AND WINDOWS

### Technical Parameters:

Frame thickness: 2.0mm

### Size rang:

Sash width 500mm-950mm, Sash height 1200mm-3500mm

### Glass specification:

5mm+20A+5mm double clear tempered glass

### Heat insulation strip:

14.8mm

### Product function:

Sliding door Two tracks and two fans/Two tracks and four fans Three tracks with two panels and gauze/Three tracks with three panels /Three tracks with four panels and gauze/three tracks with six panels

### Product advantage:

1. Multi-folding design with oversized opening, provides a clear and wide view
2. It is equipped with an anti-pinch design for safety and reliability
3. This series can be partially opened or fully expanded as needed for versatile and flexible adjustments
4. When closed it provides effective sound insulation and sealing performance



## PRODUCT ACCESSORIES



Pull Handle

\*1" Shaped Lock, Lower Wheels

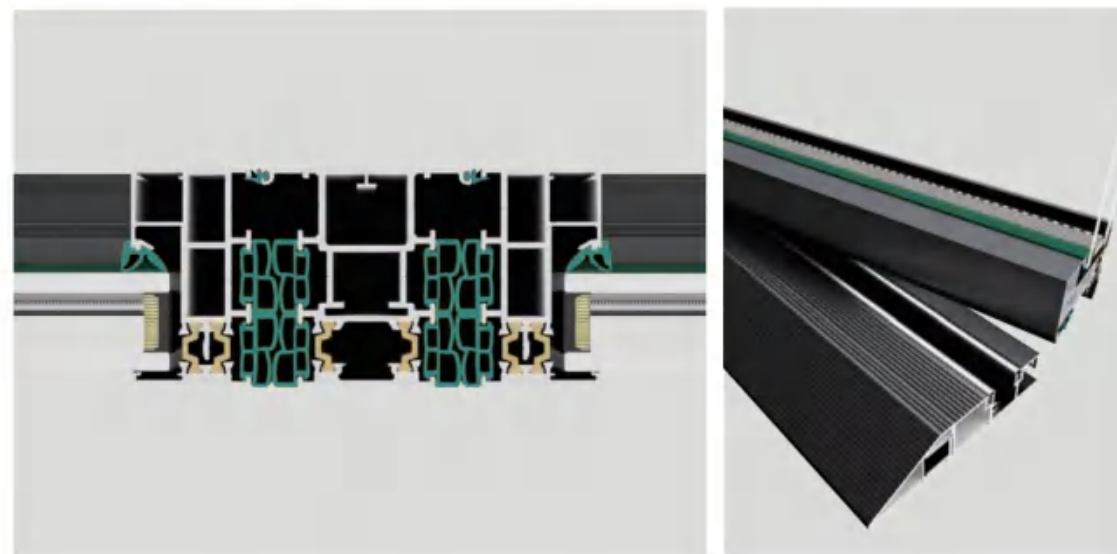

## HARDWARE CONFIGURATION

Simplicity The minimalist design concept eliminates unnecessary decorations and creates a peaceful and comfortable living space.

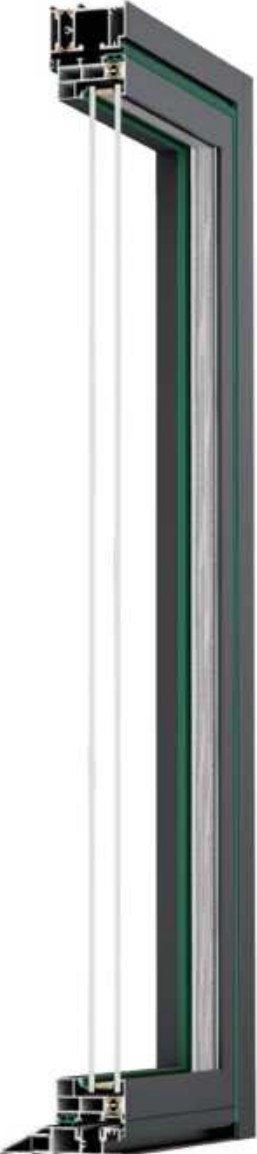
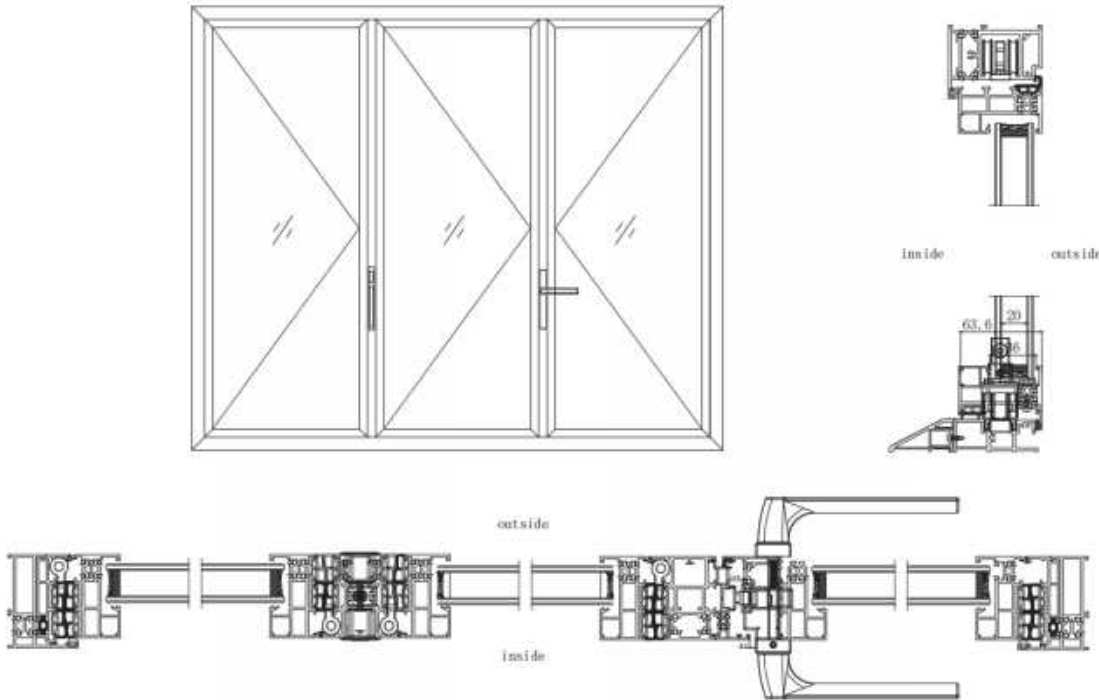

SHOWCASE GRAPH

# 86 SERIES

THERMAL BREAK HIDE HINGE FOLDING DOOR

## HIGH-END SYSTEM DOORS AND WINDOWS

### Technical Parameters:

Frame thickness: 2.0mm

### Size rang:

Sash width 500mm-850mm, Sash height 800mm-2800mm

### Glass specification:

5mm+27A+5mm double clear tempered glass

### Product function:

Folding door Odd number fold +0/Odd number fold + odd number fold/even number +0/Even number + even number

### Product advantage:

1. Multi-folding design with oversized opening, provides a clear and wide view
2. It is equipped with an anti-pinch design for safety and reliability
3. This series can be partially opened or fully expanded as needed for versatile and flexible adjustments
4. When closed it provides effective sound insulation and sealing performance
5. It is available in both inside and outside folding options to fit more spaces

### PRODUCT ACCESSORIES



Lock Cylinder with Keys \  
Lock Set \ Pull Handle



Wheels \ Driver \ Bolt \ Hinges



Door Handle

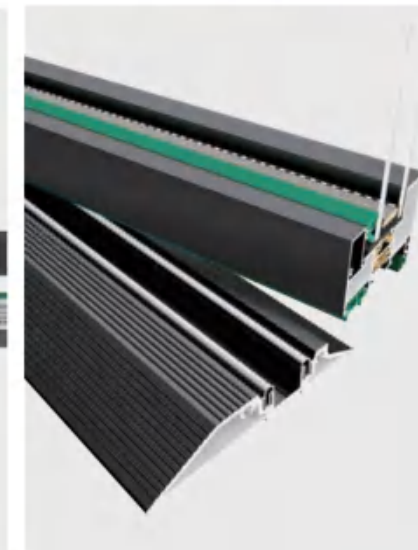
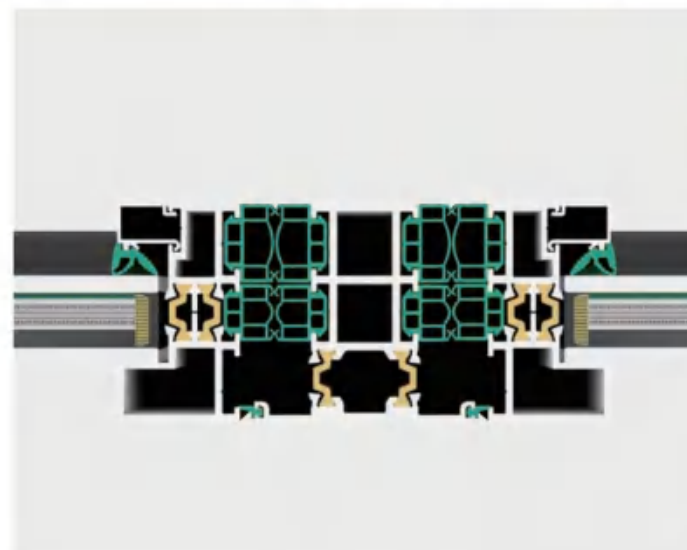

## HARDWARE CONFIGURATION

*Simplicity The minimalist design concept eliminates unnecessary decorations and creates a peaceful and comfortable living space.*

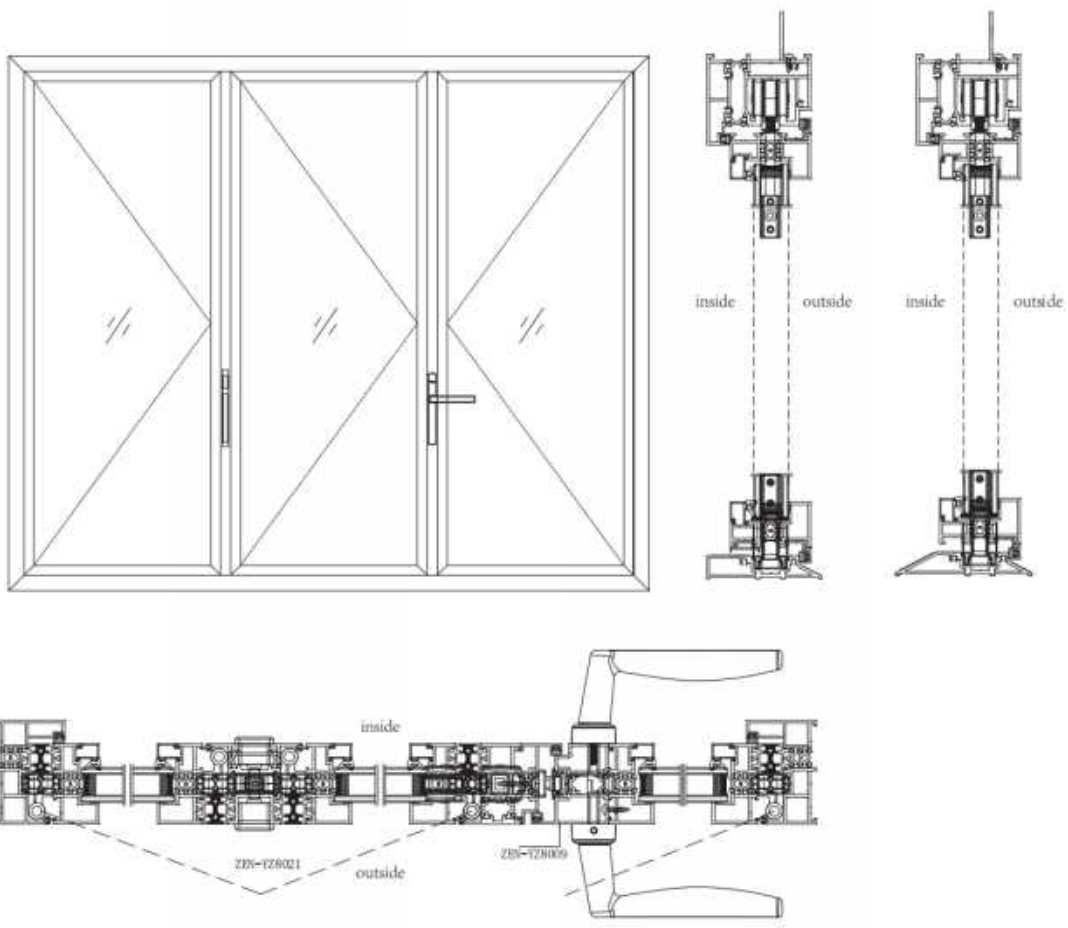

SHOWCASE GRAPH

**Technical Parameters:**

Frame thickness: 2.0mm

**Size rang:**

Sash width 500mm-850mm, Sash height 700mm-2800mm

**Glass specification:**

5mm+27A+5mm double clear tempered glass

**Product function:**

Folding door Odd number fold +0/Odd number fold + odd number fold/even number +0/Even number + even number

**Product advantage:**

1. Multi-folding design with oversized opening, provides a clear and wide view
2. It is equipped with an anti-pinch design for safety and reliability
3. This series can be partially opened or fully expanded as needed for versatile and flexible adjustments
4. When closed it provides effective sound insulation and sealing performance
5. It is available in both inside and outside folding options to fit more spaces



## PRODUCT ACCESSORIES



Upper Wheels, Lower Wheels



Multi-point lock body\Hinges\Driver\  
Lock Cylinder\Upper and Lower Bolts

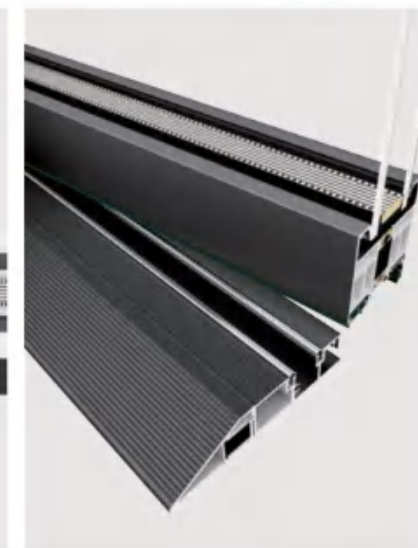
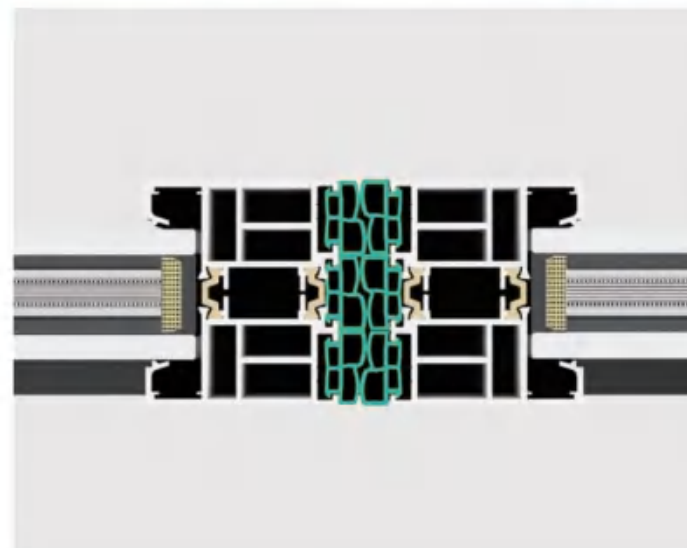

## HARDWARE CONFIGURATION

*Simplicity The minimalist design concept eliminates unnecessary decorations and creates a peaceful and comfortable living space.*

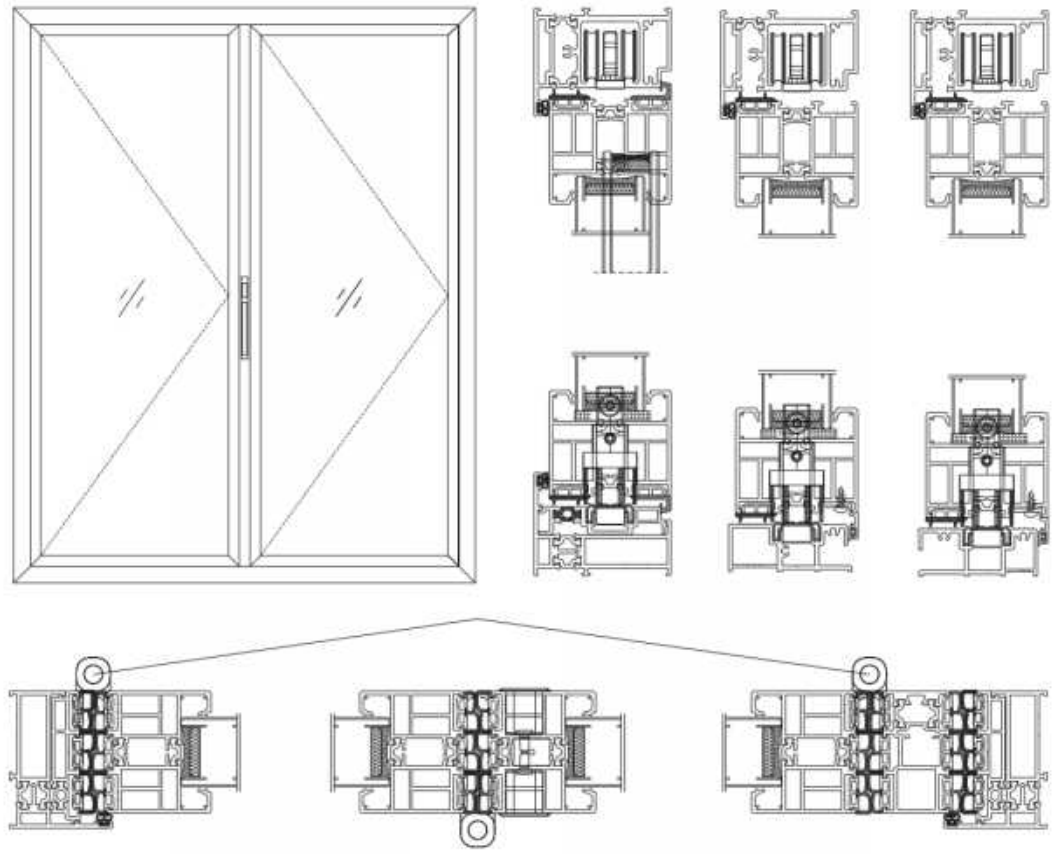

SHOWCASE GRAPH

**Technical Parameters:**

Frame thickness: 2.0mm

**Size rang:**

Sash width 500mm-950mm, Sash height 1200mm-3500mm

**Glass specification:**

5mm+27A+5mm double clear tempered glass

**Heat insulation strip:**

24mm

**Product function:**

Folding door Odd number fold +0/Odd number fold + odd number fold/even number +0/Even number + even number

**Product advantage:**

- 1、 Folding design, 100% full opening, effective space saving, more open view
- 2、 It adopts tempered hollow glass design, which effectively reduces noise and achieves the best sound insulation effect
- 3、 It is equipped with high-quality sliding rails, folds easily and smoothly, and is durable
- 4、 Door hinge are flexible and can be customized according to needs

**PRODUCT ACCESSORIES**



Hinges \ Invisible Handle \ Driver \  
Upper and Lower Wheels \ Upper and Lower Bolts



Door Handle \ Lock Cylinder with Keys \  
Multi-point lock body

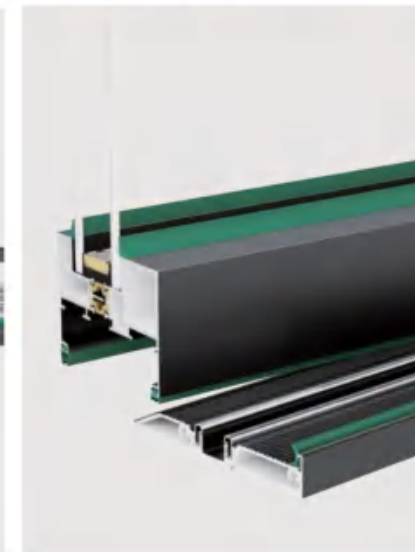
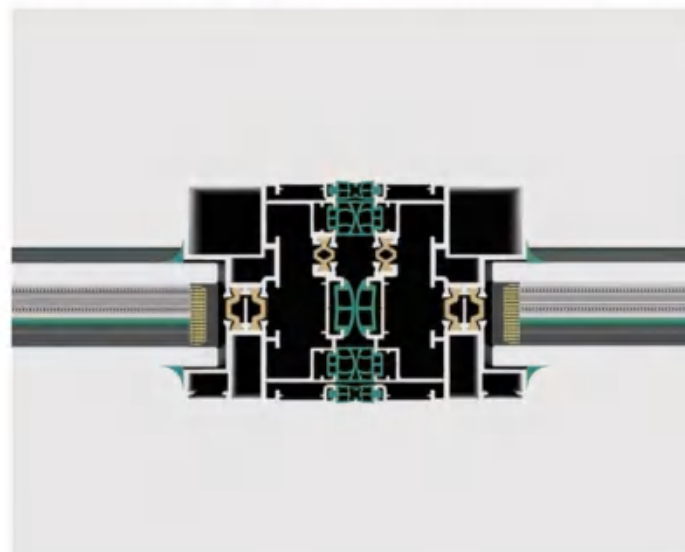

**HARDWARE CONFIGURATION**

*Simplicity The minimalist design concept eliminates unnecessary decorations and creates a peaceful and comfortable living space.*

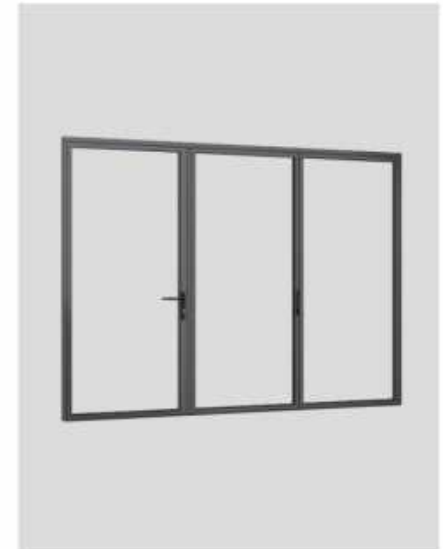
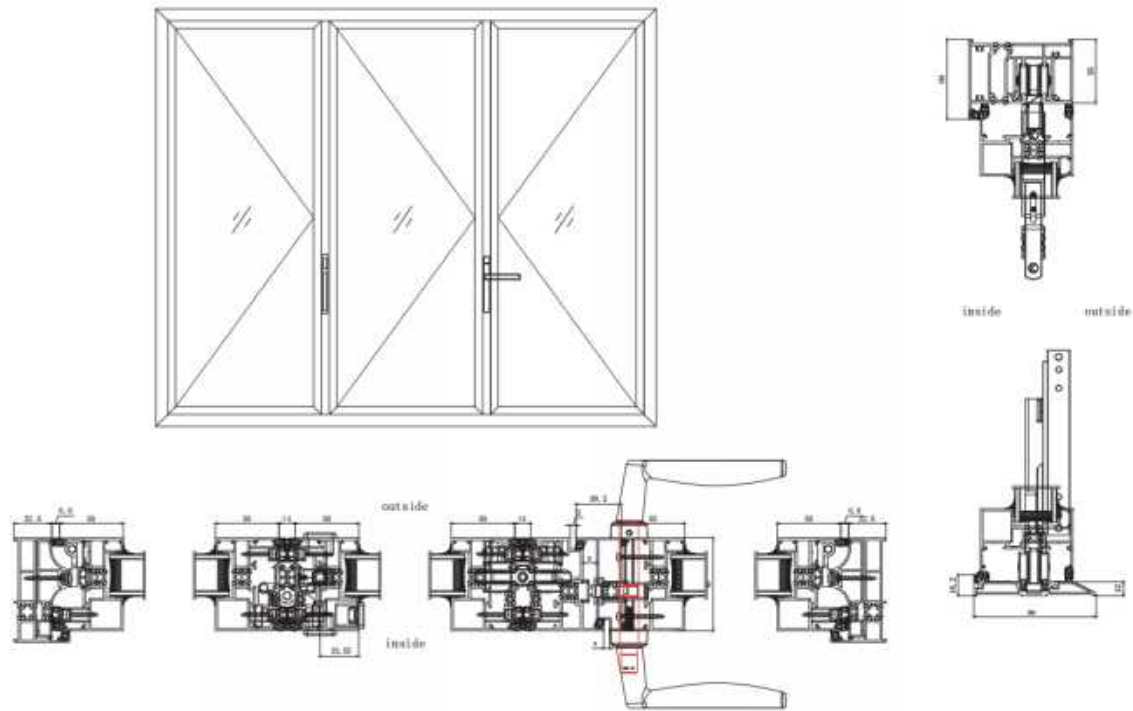

SHOWCASE GRAPH

# 95 SERIES

THERMAL BREAK HIDE HINGE FOLDING DOOR

# HIGH-END SYSTEM DOORS AND WINDOWS

**Technical Parameters:**

Frame thickness: 0.0mm

**Size rang:**

Sash width 000mm-0000mm, Sash height 000mm-0000mm

**Glass specification:**

5mm+00A+5mm double clear tempered glass

**Product function:**

Sliding door

**Product advantage:**

- 1、 Multi-folding design with oversized opening, provides a clear and wide view
- 2、 It is equipped with an anti-pinch design for safety and reliability
- 3、 This series can be partially opened or fully expanded as needed for versatile and flexible adjustments
- 4、 When closed it provides effective sound insulation and sealing performance



## PRODUCT ACCESSORIES



Hinges\Driver\ Lock Body and Lock Set For Doors

Handle\Lock Cylinder with Keys

Lock Body

Upper Wheels\Lower Wheels

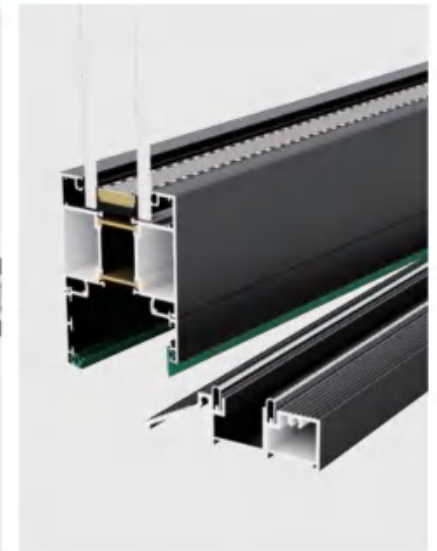
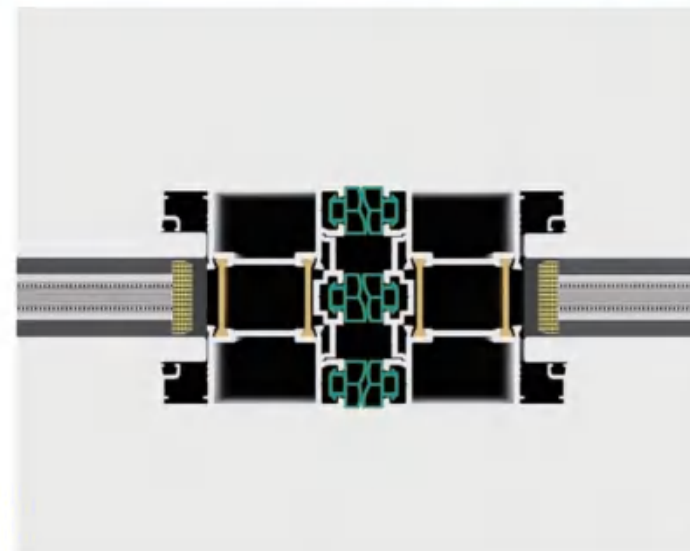

## HARDWARE CONFIGURATION

*Simplicity The minimalist design concept eliminates unnecessary decorations and creates a peaceful and comfortable living space.*

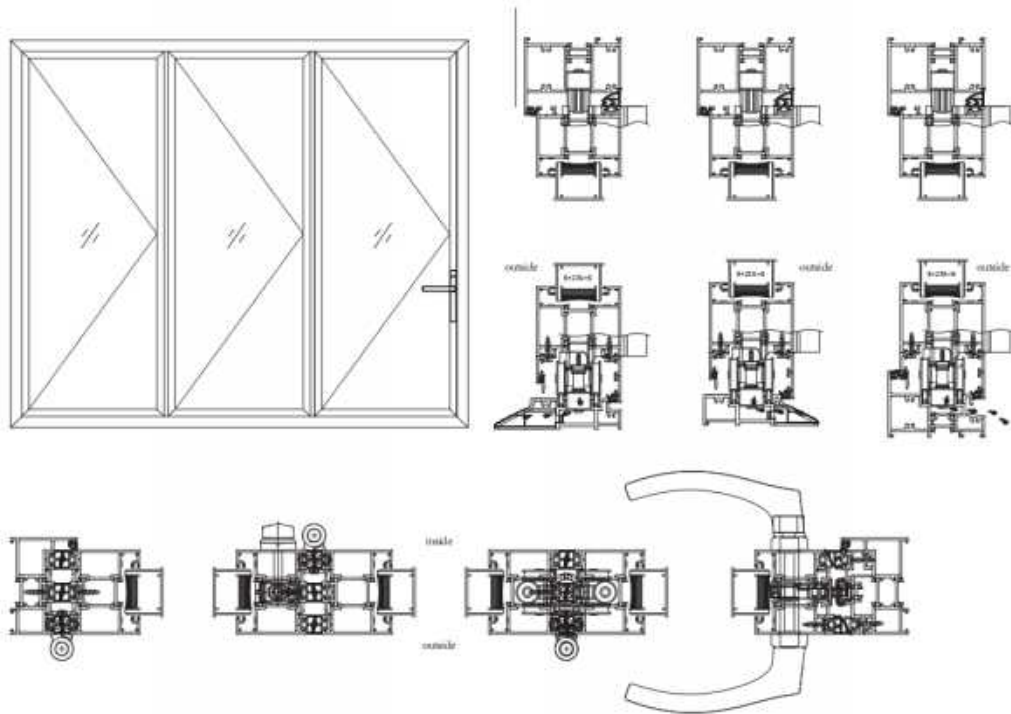

SHOWCASE GRAPH

# 60 SERIES THERMAL BREAK FOLDING WINDOW

# HIGH-END SYSTEM DOORS AND WINDOWS

### Technical Parameters:

Frame thickness: 2.0mm

### Size rang:

Sash width 500mm-1400mm, Sash height 500mm-800mm

### Glass specification:

5mm+20A+5mm double clear tempered glass

### Heat insulation strip:

20mm

### Product function:

Folding window Even numbers are multiplied by +0 Even number fold + even number fold  
Even number fold + odd number fold

### Product advantage:

1. Left and right can be freely folded, larger opening angle, better viewing and ventilation effect
2. Roller screens can be selected to meet the needs of mosquito protection and glare blocking.
3. Bridge cut-off design, has better heat and sound insulation, and can reach more energy-saving and environmental protection
4. Outer flat frame design drives no water and dust accumulation

## PRODUCT ACCESSORIES



Hinges\Pulling Hinges\Square Axle

Transmission Box\Hanging Wheels\Handle\  
Hinges\Upper and Lower Bolts

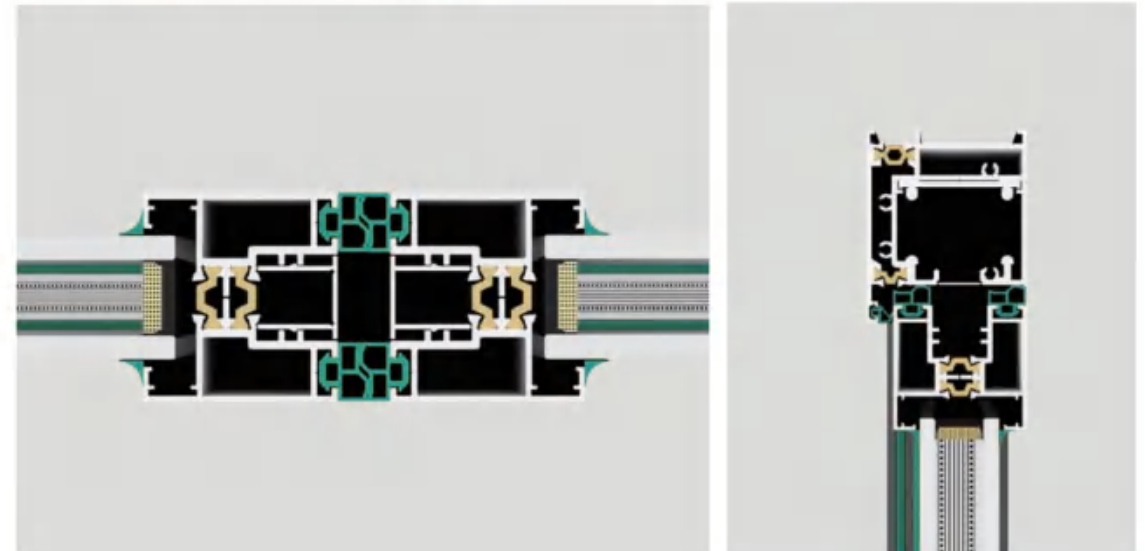

## HARDWARE CONFIGURATION

*Simplicity The minimalist design concept eliminates unnecessary decorations and creates a peaceful and comfortable living space.*

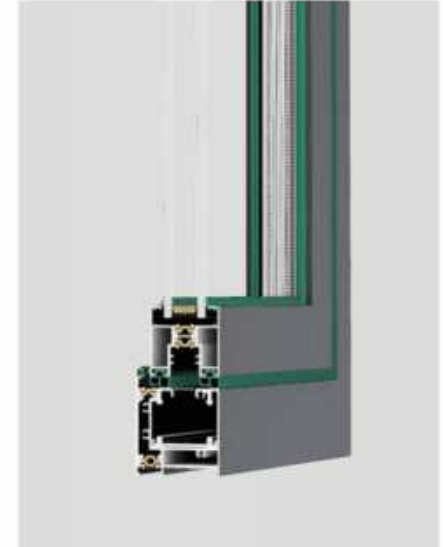
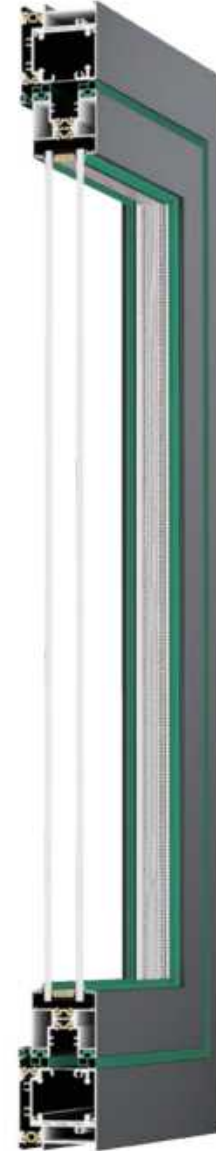
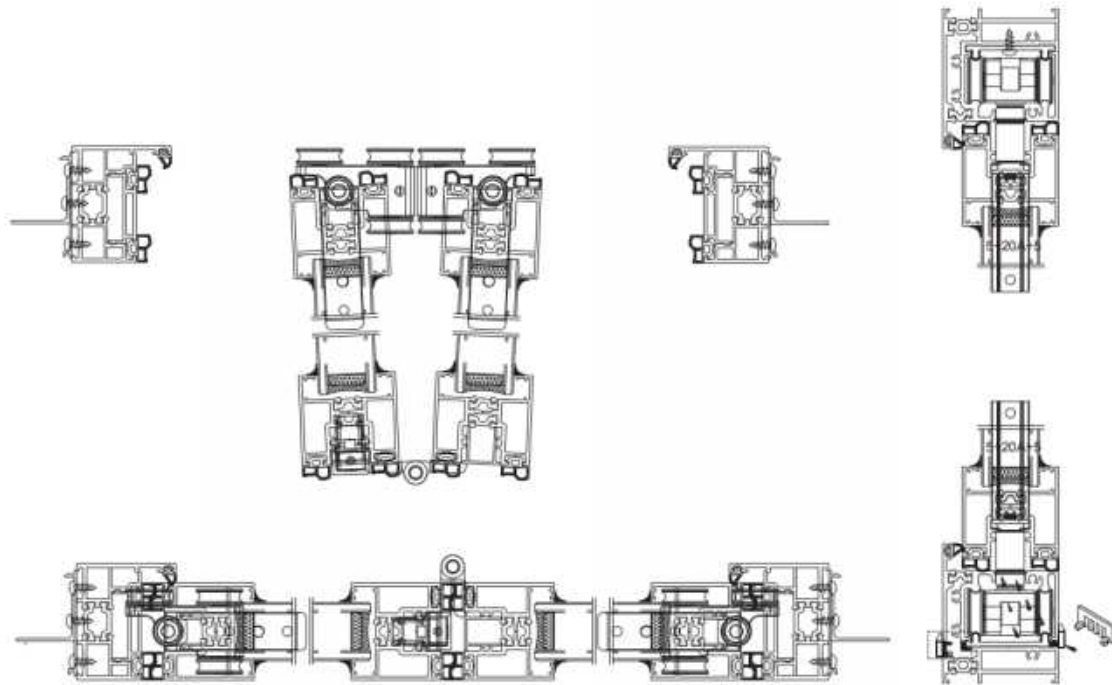

SHOWCASE GRAPH

# 55 SERIES

NON-THERMAL BREAK UP AND DOWN FOLDING WINDOW

# HIGH-END SYSTEM DOORS AND WINDOWS

### Technical Parameters:

Frame thickness: 1.2mm

### Glass specification:

5mm+9A+5mm double clear tempered glass

### Product function:

Fold up

### Product advantage:

1. Small wall occupation design, meets the needs of more thin wall thickness
2. Roller screens can be selected to meet the needs of mosquito protection and glare blocking
3. Upper and lower folding opening design has a larger opening angle for better viewing and ventilation
4. That this series is made of 6063 profiles, which has high quality, and is strong, durable, corrosion resistant



## PRODUCT ACCESSORIES



Handle\Driver\Spring Piece\Hinges\Pulling Hinges



## HARDWARE CONFIGURATION

*Simplicity The minimalist design concept eliminates unnecessary decorations and creates a peaceful and comfortable living space.*

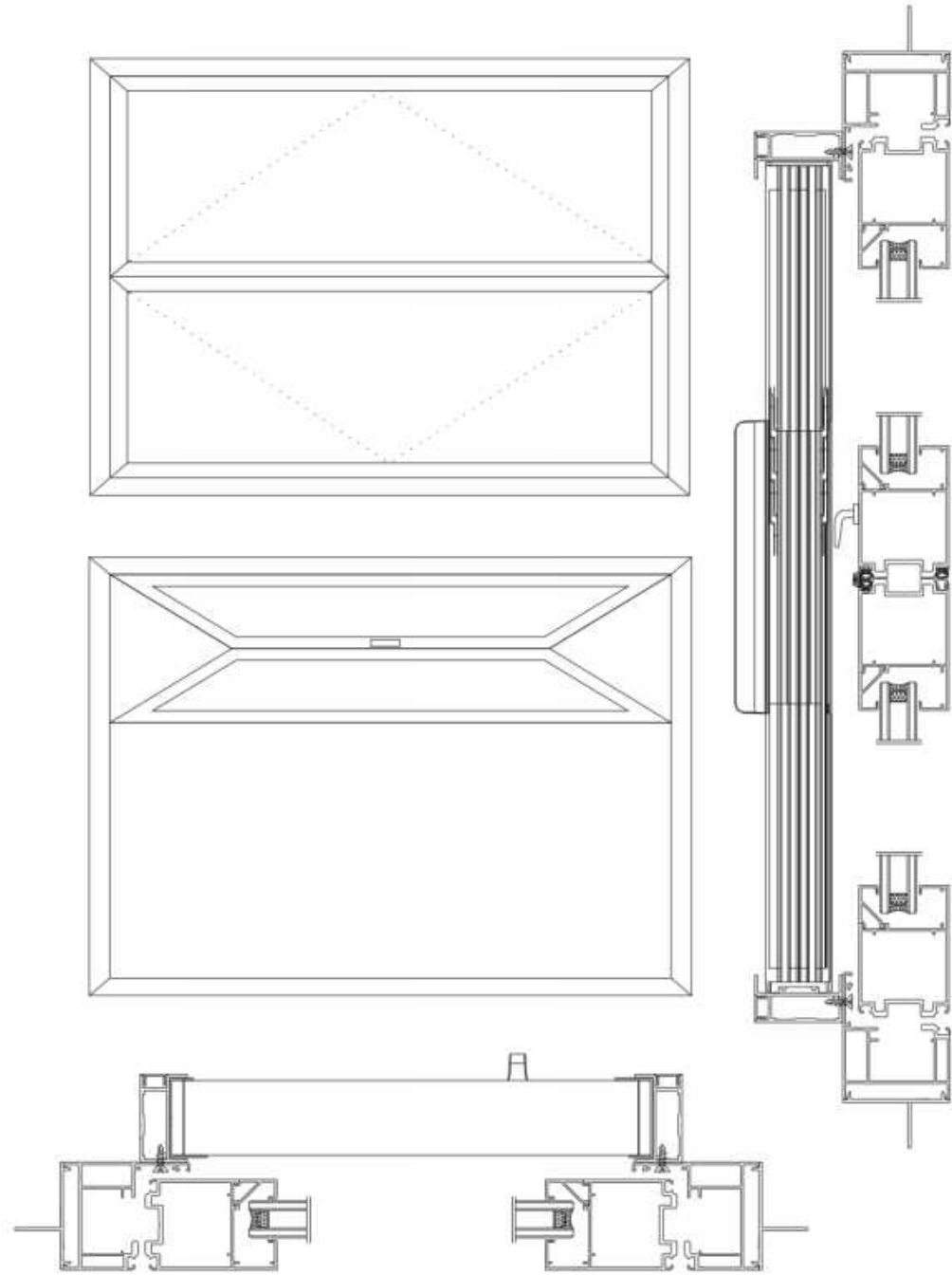

SHOWCASE GRAPH

# 83 SERIES

THERMAL BREAK UP AND DOWN SINGLE HUNG WINDOW

# HIGH-END SYSTEM DOORS AND WINDOWS

### Technical Parameters:

Frame thickness: 1.4mm

### Size rang:

Sash width 400mm-1450mm, Sash height 400mm-1200mm

### Glass specification:

5mm+15A+5mm double clear tempered glass

### Heat insulation strip:

10mm

### Product function:

Lift up and down

### Product advantage:

- 1、TWhen in the closed state, the frame wraps the sash design will be more stable,have higher wind pressure resistance
- 2、T Double-sided locking design for better sealing performance when closed
- 3、TWhen opened, the lift-pull sash design does not take up space in the room and provides better ventilation

## PRODUCT ACCESSORIES



Spring Piece Little Pull Handle limiter

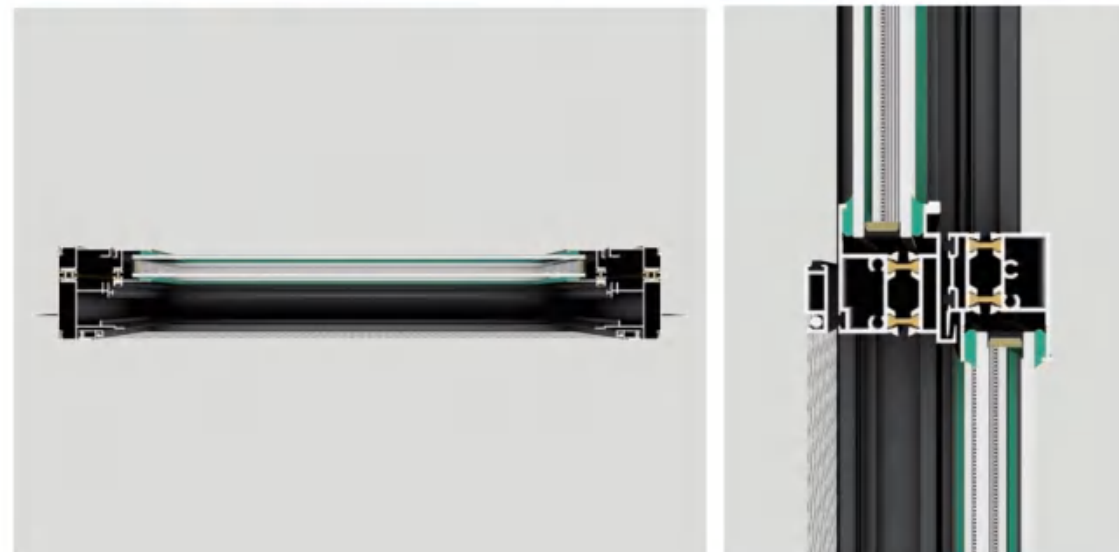

## HARDWARE CONFIGURATION

Simplicity The minimalist design concept eliminates unnecessary decorations and creates a peaceful and comfortable living space.

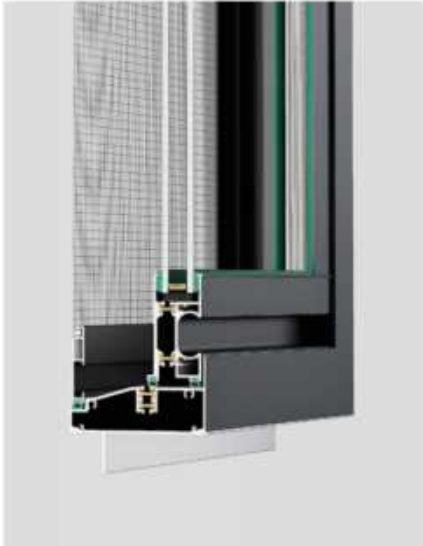
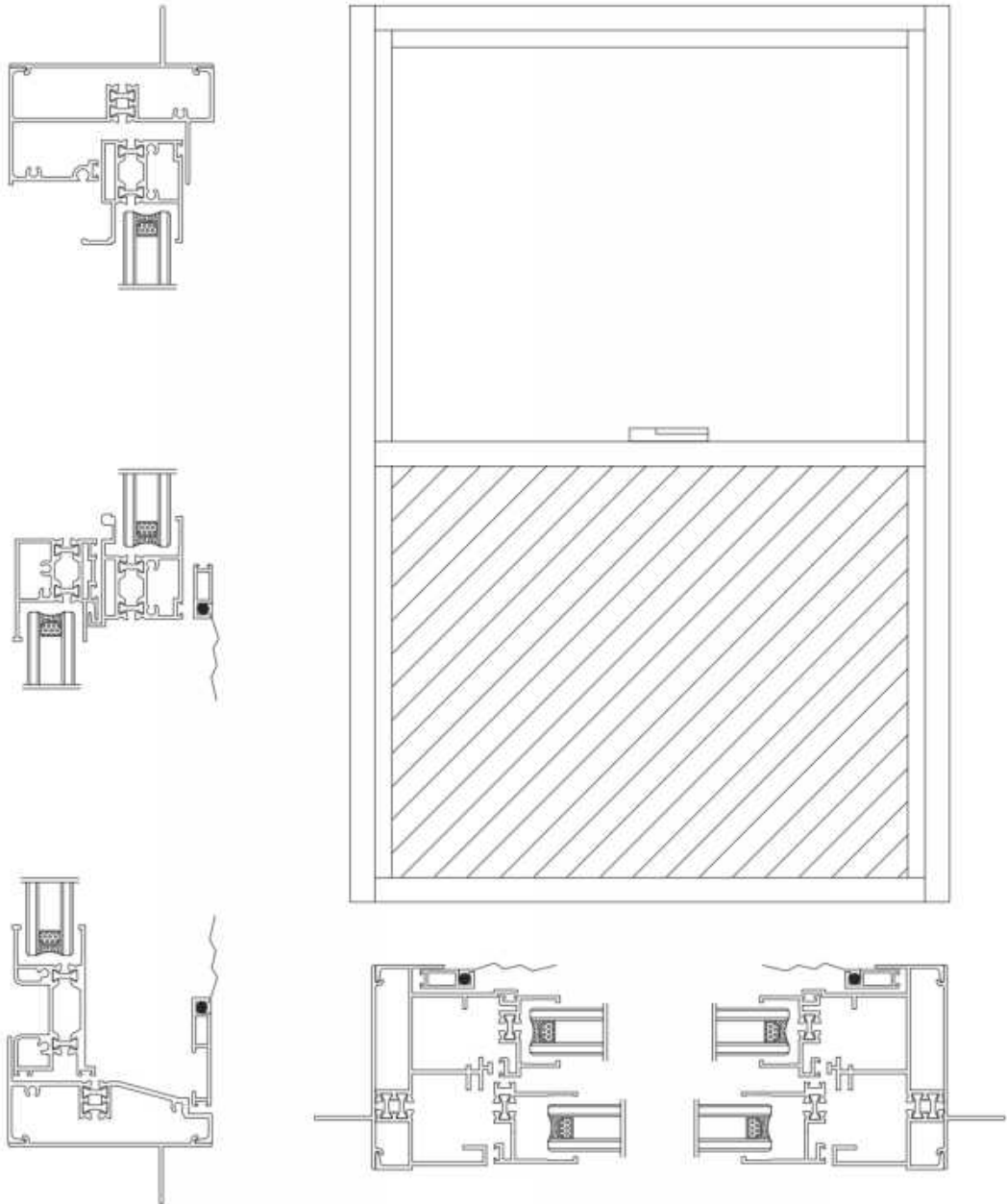

SHOWCASE GRAPH

# 100 SERIES

## HIGH-END SYSTEM DOORS AND WINDOWS

### Technical Parameters:

Frame thickness: 2.0mm

### Size rang:

Sash width 450mm-750mm, Sash height 750mm-1400mm

### Glass specification:

6mm+12A+6mm double clear tempered glass

### Heat insulation strip:

Non-broken bridge

### Product function:

Outward opening/outward overhanging

### Product advantage:

1. Open frame, hidden frame, semi-hidden frame design, can meet a variety of user needs
2. That this series is made of 6063 profiles, which has high quality, and is strong, durable, corrosion resistant.
3. Standard 6+12+6 double-layer hollow tempered glass, is safer, more stable
4. 2.0 wall thickness, load-bearing, wind pressure resistance is stronger

## PRODUCT ACCESSORIES

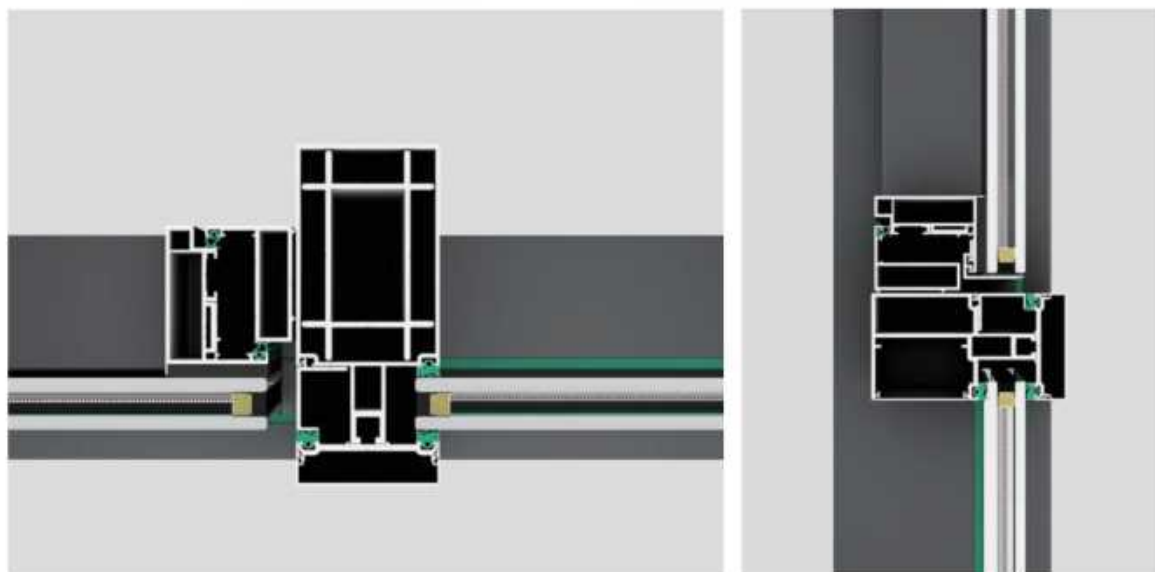

## HARDWARE CONFIGURATION

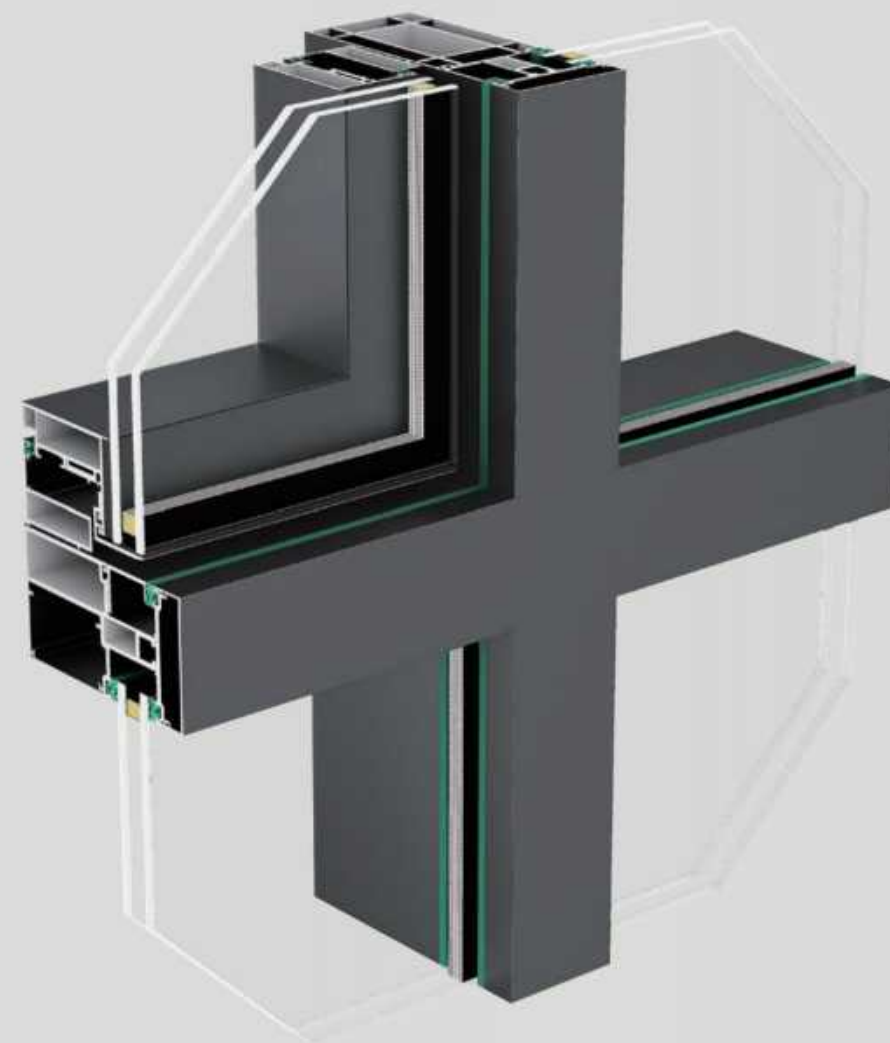

*Simplicity The minimalist design concept eliminates unnecessary decorations and creates a peaceful and comfortable living space.*

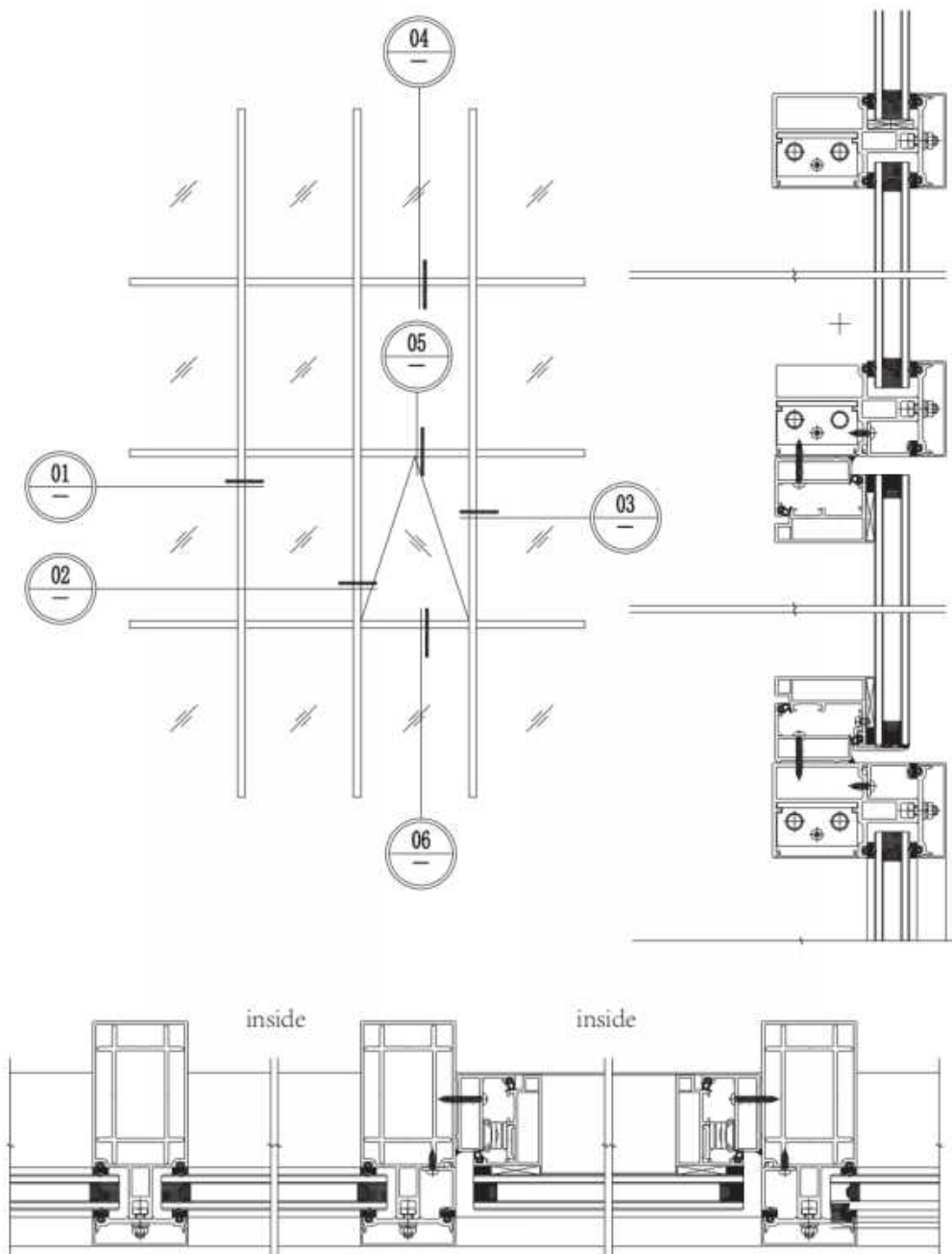

SHOWCASE GRAPH

# 120 SERIES

## HIGH-END SYSTEM DOORS AND WINDOWS

### Technical Parameters:

Frame thickness: 3.0mm

### Size rang:

Sash width 450mm-750mm, Sash height 750mm-1400mm

### Glass specification:

6mm+12A+6mm double clear tempered glass

### Heat insulation strip:

Non-broken bridge

### Product function:

Outward opening/outward overhanging

### Product advantage:

1. Open frame, hidden frame, semi-hidden frame design, can meet a variety of user needs
2. That this series is made of 6063 profiles, which has high quality, and is strong, durable, corrosion resistant.
3. Standard 6+12+6 double-layer hollow tempered glass, is safer, more stable
4. 3.0 wall thickness, load-bearing, wind pressure resistance is stronger

## PRODUCT ACCESSORIES

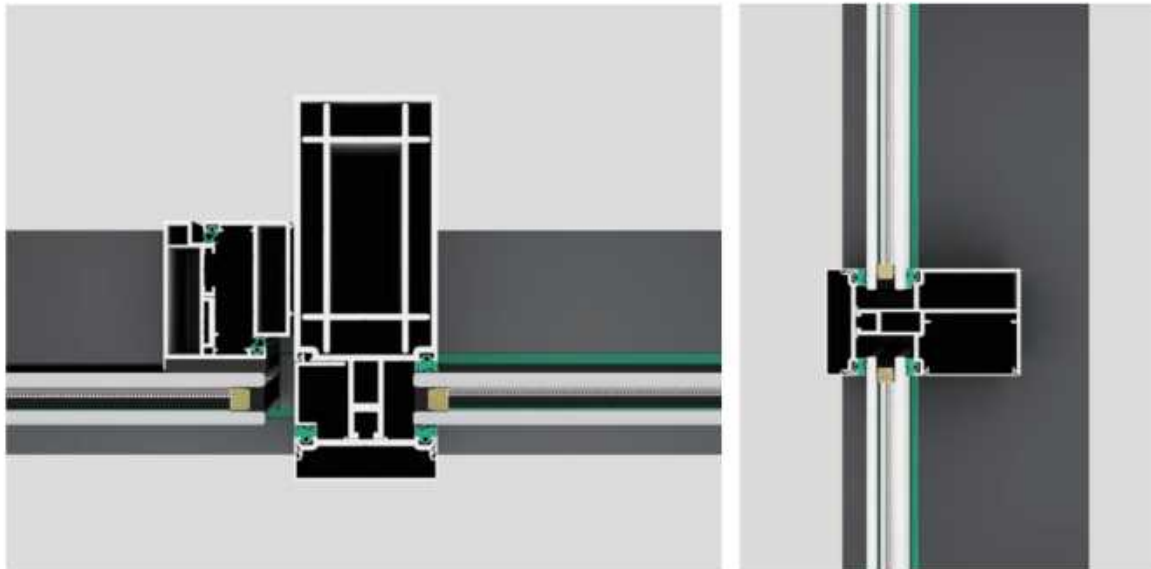

## HARDWARE CONFIGURATION

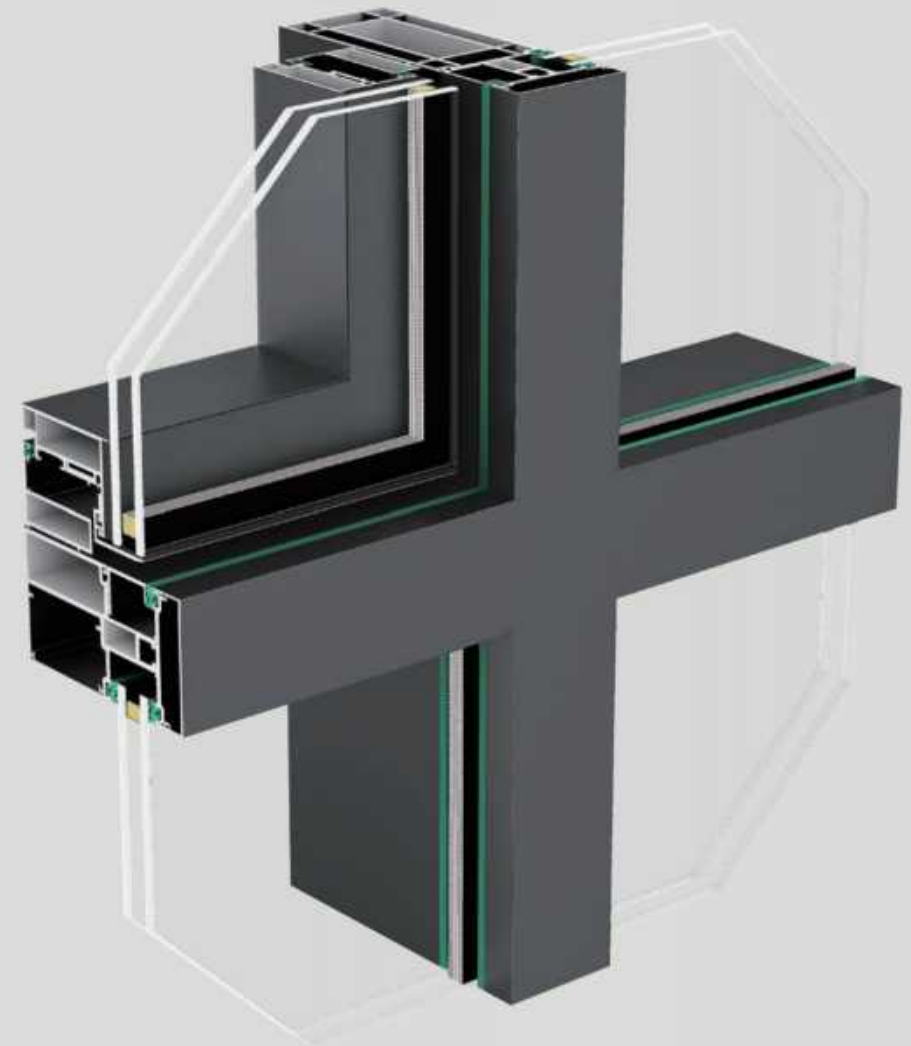

*Simplicity The minimalist design concept eliminates unnecessary decorations and creates a peaceful and comfortable living space.*

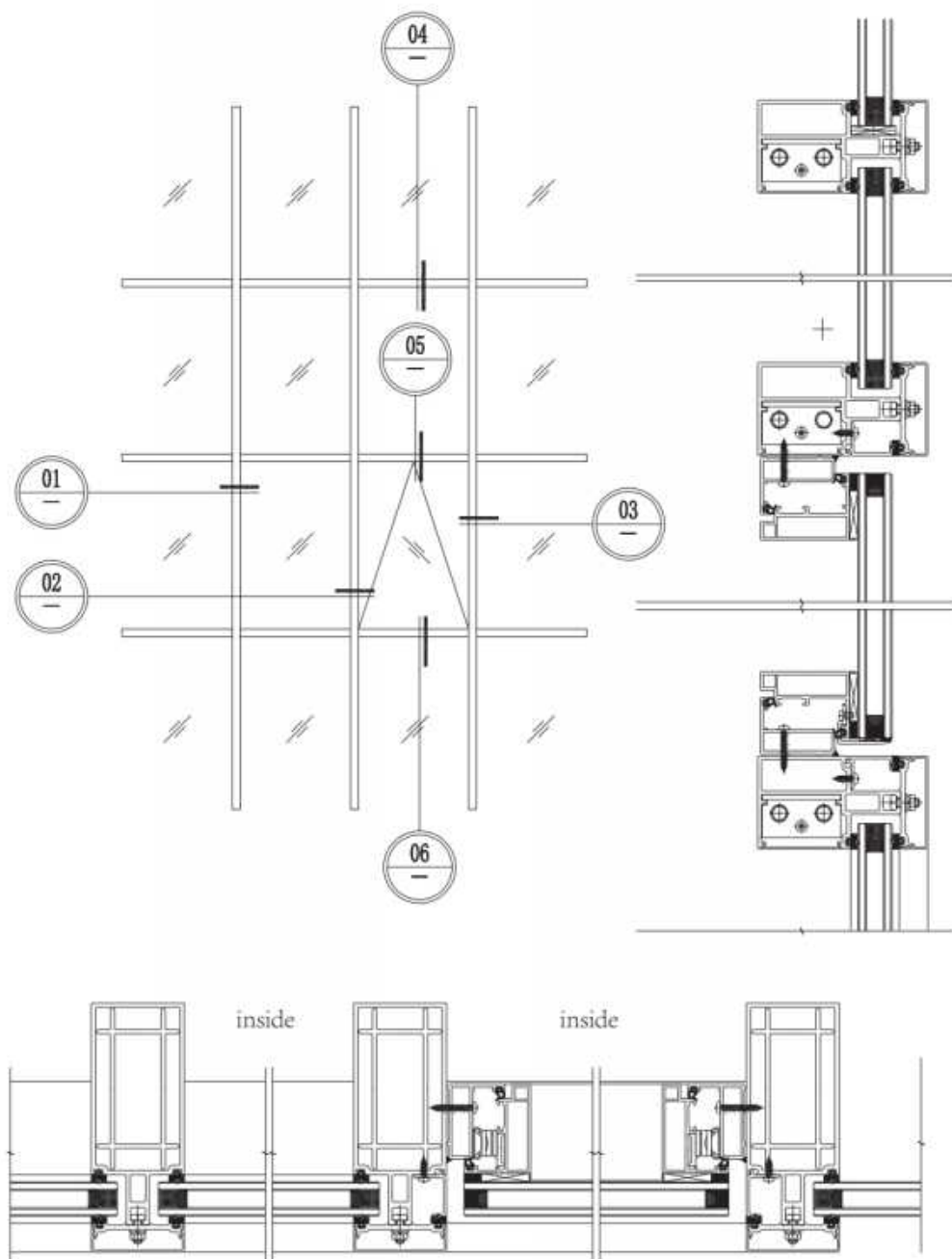

SHOWCASE GRAPH

# 140 SERIES

## HIGH-END SYSTEM DOORS AND WINDOWS

### Technical Parameters:

Frame thickness: 3.0mm

### Size rang:

Sash width 450mm-750mm, Sash height 750mm-1400mm

### Glass specification:

6mm+12A+6mm double clear tempered glass

### Heat insulation strip:

Non-broken bridge

### Product function:

Outward opening/outward overhanging

### Product advantage:

1. Open frame, hidden frame, semi-hidden frame design, can meet a variety of user needs
2. That this series is made of 6063 profiles, which has high quality, and is strong, durable, corrosion resistant.
3. Standard 6+12+6 double-layer hollow tempered glass, is safer, more stable
4. 3.0 wall thickness, load-bearing, wind pressure resistance is stronger

## PRODUCT ACCESSORIES

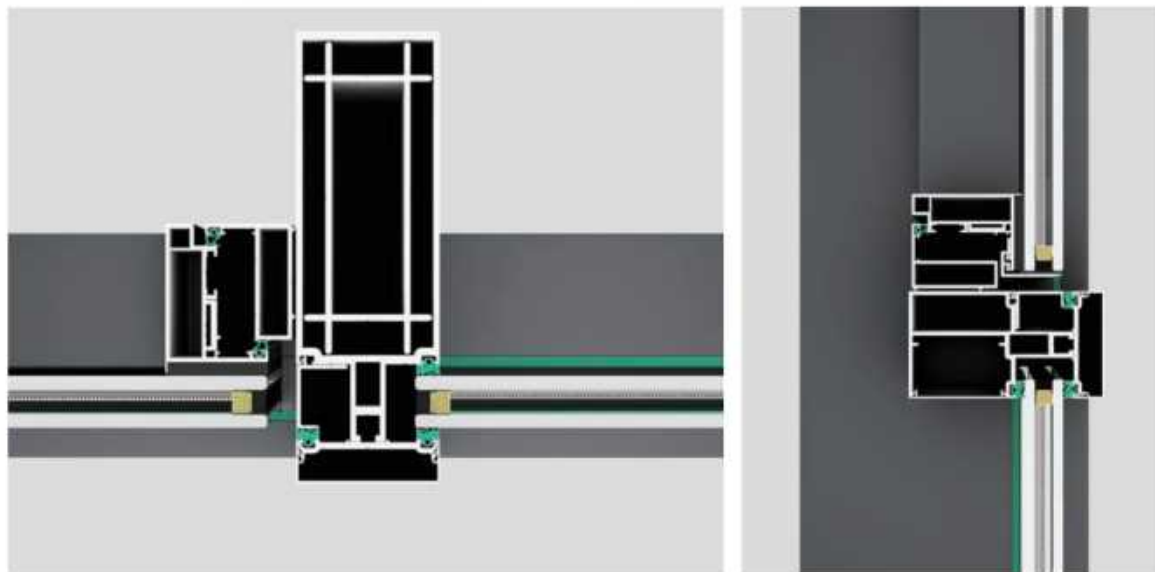

## HARDWARE CONFIGURATION

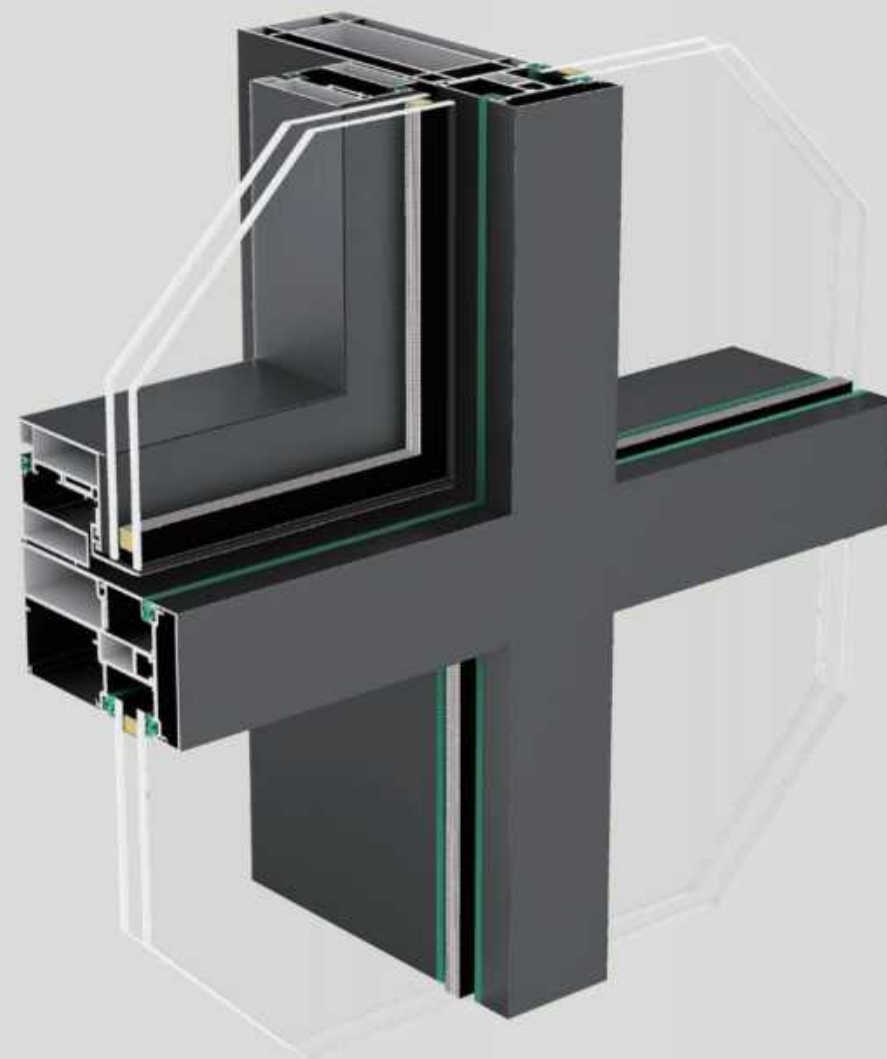

*Simplicity The minimalist design concept eliminates unnecessary decorations and creates a peaceful and comfortable living space.*

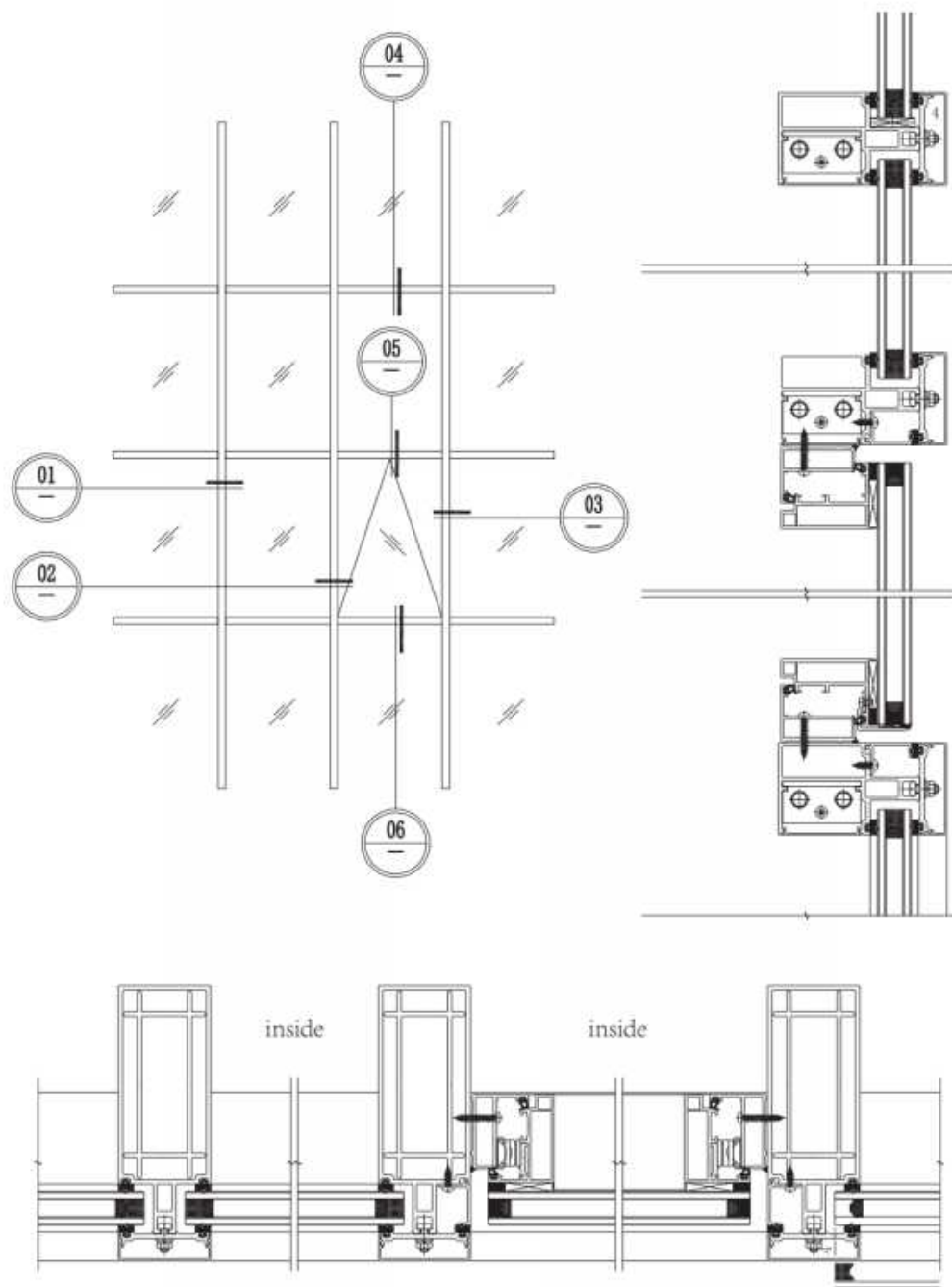

SHOWCASE GRAPH

# 180 SERIES

## HIGH-END SYSTEM DOORS AND WINDOWS

### Technical Parameters:

Frame thickness: 3.0mm

### Size rang:

Sash width 450mm-750mm, Sash height 750mm-1400mm

### Glass specification:

6mm+12A+6mm double clear tempered glass

### Heat insulation strip:

Non-broken bridge

### Product function:

Outward opening/outward overhanging

### Product advantage:

1. Open frame, hidden frame, semi-hidden frame design, can meet a variety of user needs
2. That this series is made of 6063 profiles, which has high quality, and is strong, durable, corrosion resistant.
3. Standard 6+12+6 double-layer hollow tempered glass, is safer, more stable
4. 3.0 wall thickness, load-bearing, wind pressure resistance is stronger

## PRODUCT ACCESSORIES

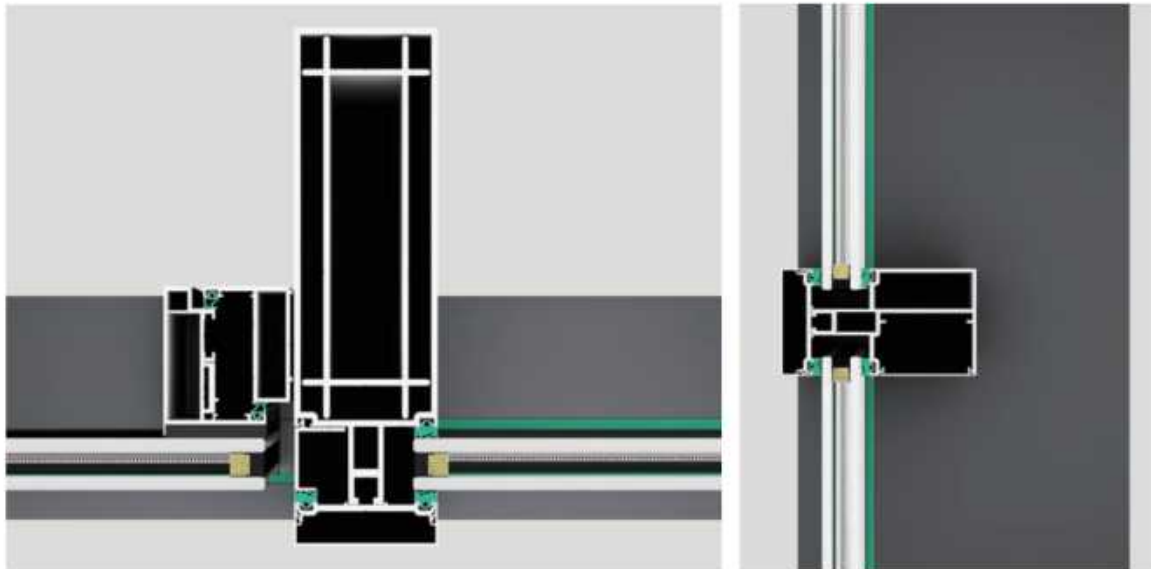

## HARDWARE CONFIGURATION

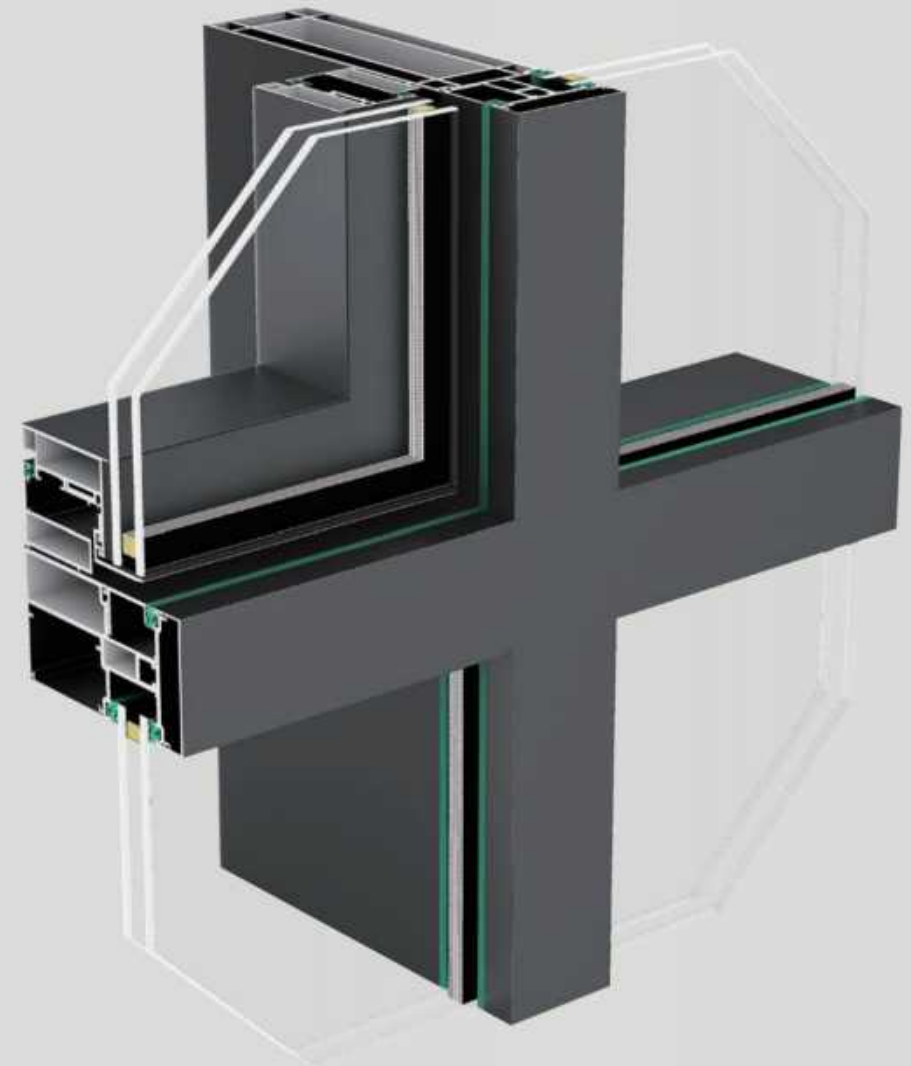

*Simplicity The minimalist design concept eliminates unnecessary decorations and creates a peaceful and comfortable living space.*

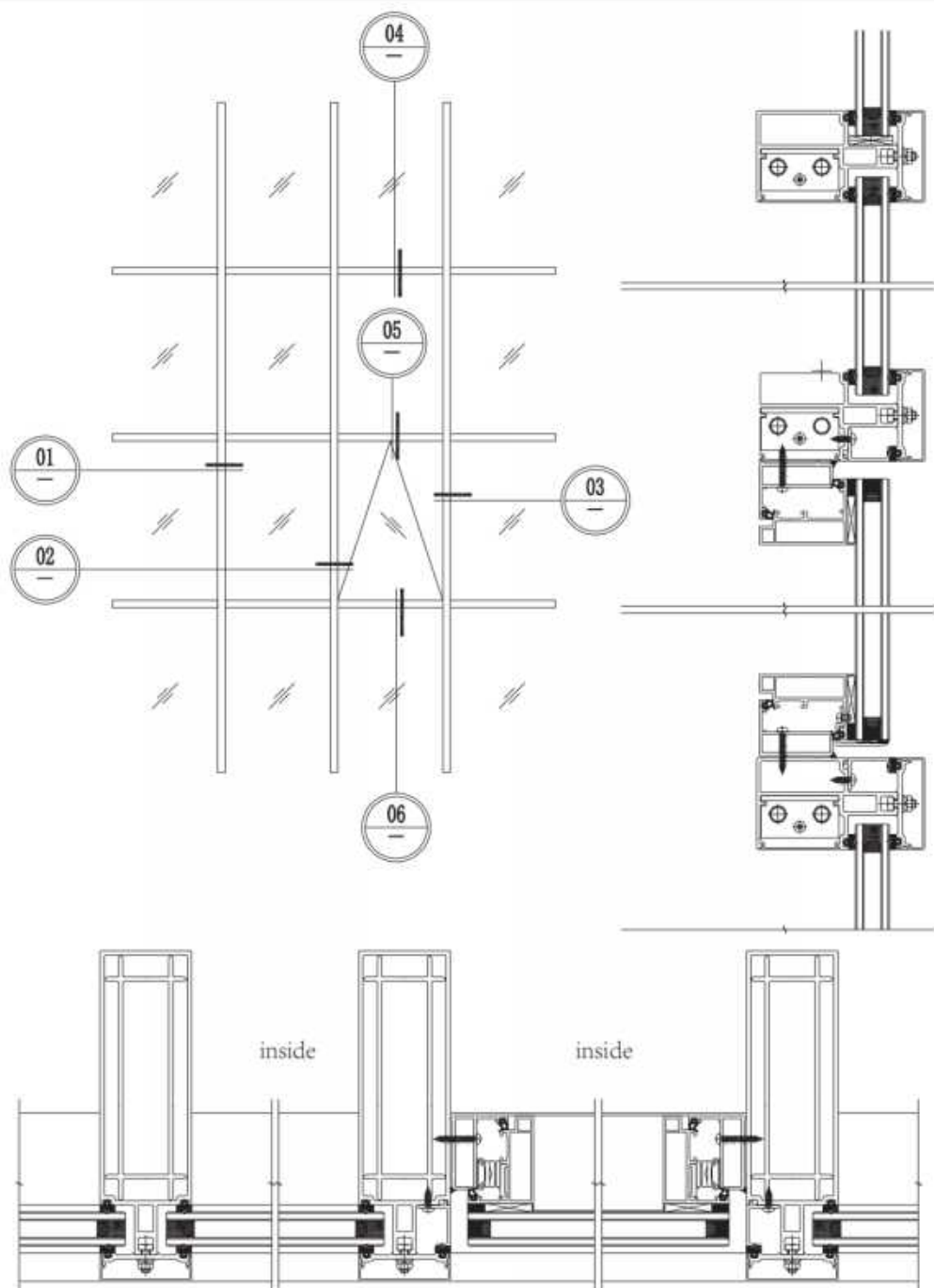

SHOWCASE GRAPH

# 55 SERIES

KFC DOOR/SPRING DOOR

## HIGH-END SYSTEM DOORS AND WINDOWS

### Technical Parameters:

Frame thickness: 2.2mm

### Size rang:

Sash width 400mm-1200mm, Sash height 1500mm-2800mm

### Glass specification:

5mm+15A+5mm double clear tempered glass

### Product function:

Outward opening door, inward opening door, single opening door, double opening door

### Product advantage:

1. the use of high-strength aluminum alloy, high corrosion resistance and wind pressure resistance
2. the appearance design is fashionable and simple, in line with the image needs of various commercial places
3. automatic rebound closing function design, convenient for customers to enter and exit
4. effectively isolate dust and rain, keep the room clean

### PRODUCT ACCESSORIES



Horizontal handle



Vertical handle



Safety Chain



Accessories of Floor Spring



Floor Spring



Limiter

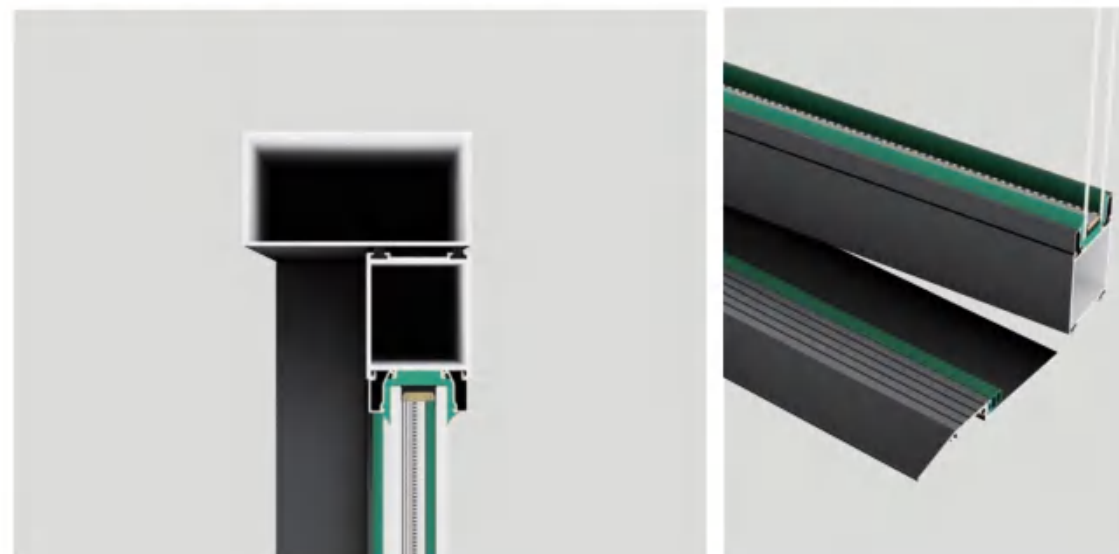

## HARDWARE CONFIGURATION

*Simplicity The minimalist design concept eliminates unnecessary decorations and creates a peaceful and comfortable living space.*

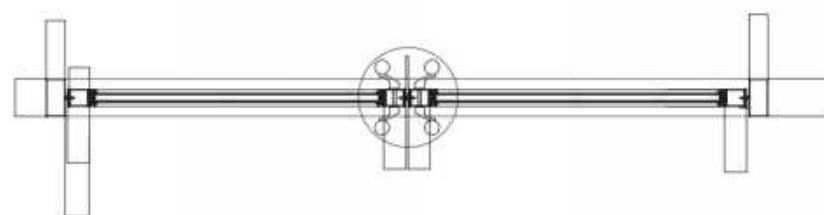
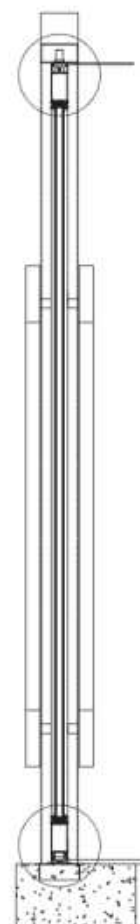
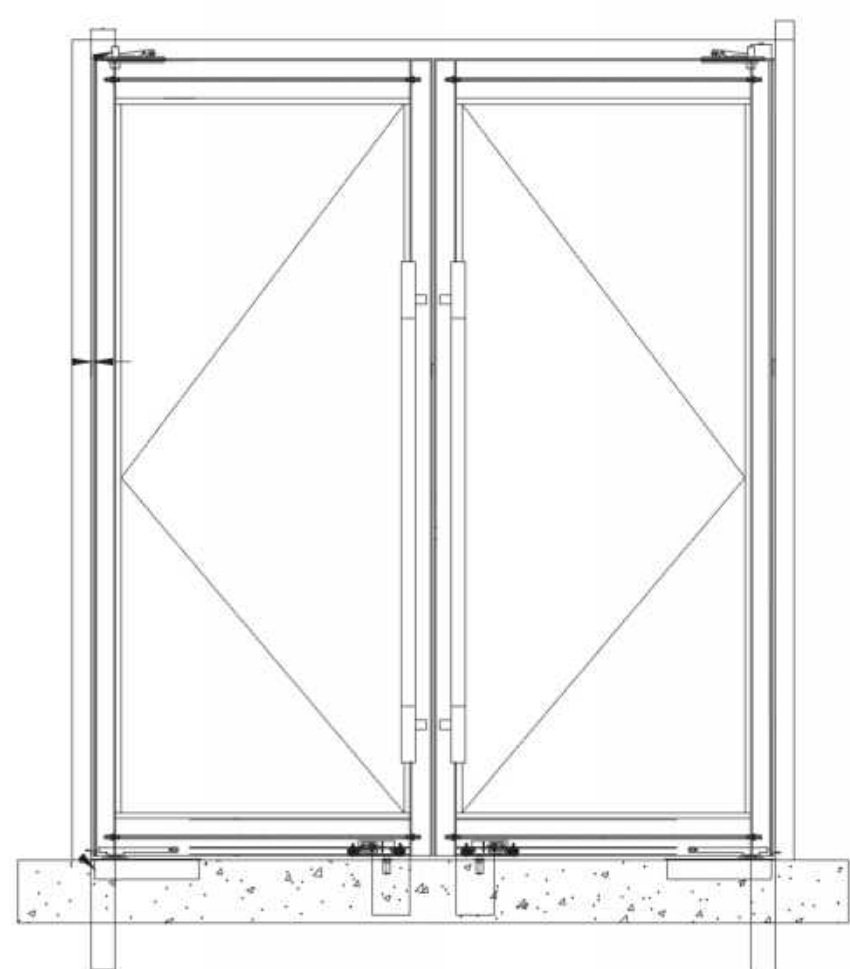

SHOWCASE GRAPH

### Technical Parameters:

Frame thickness: 2.2mm

### Size rang:

Sash width 400mm-1200mm, Sash height 1500mm-2800mm

### Glass specification:

5mm+15A+5mm double clear tempered glass

### Product function:

Outward opening door, inward opening door, single opening door, double opening door

### Product advantage:

1. the use of high-strength aluminum alloy, high corrosion resistance and wind pressure resistance
2. the appearance design is fashionable and simple, in line with the image needs of various commercial places
3. automatic rebound closing function design, convenient for customers to enter and exit
4. effectively isolate dust and rain, keep the room clean

## PRODUCT ACCESSORIES

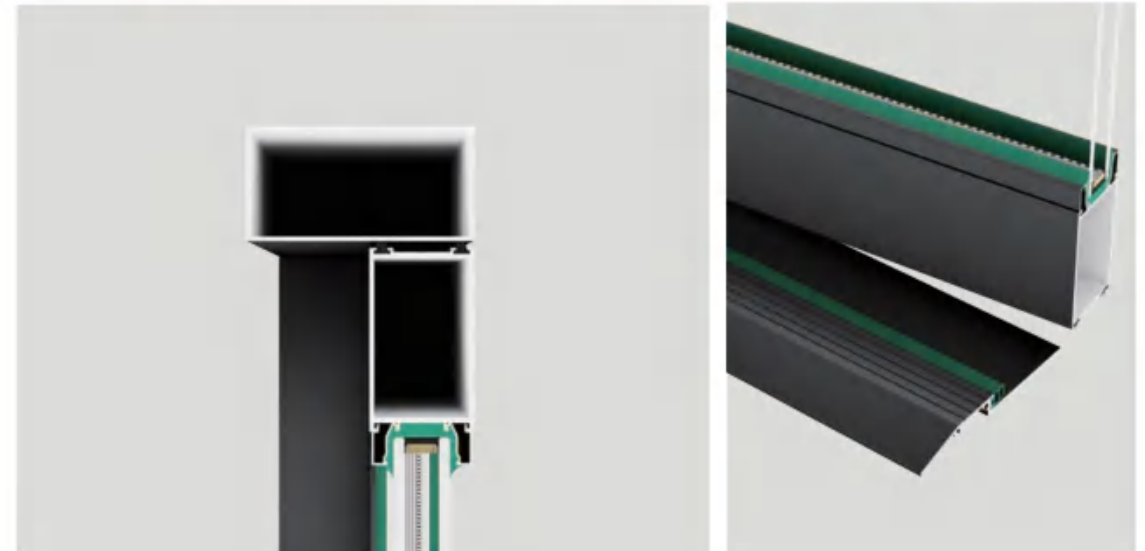

## HARDWARE CONFIGURATION

*Simplicity The minimalist design concept eliminates unnecessary decorations and creates a peaceful and comfortable living space.*

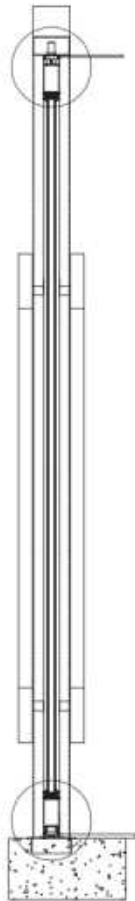
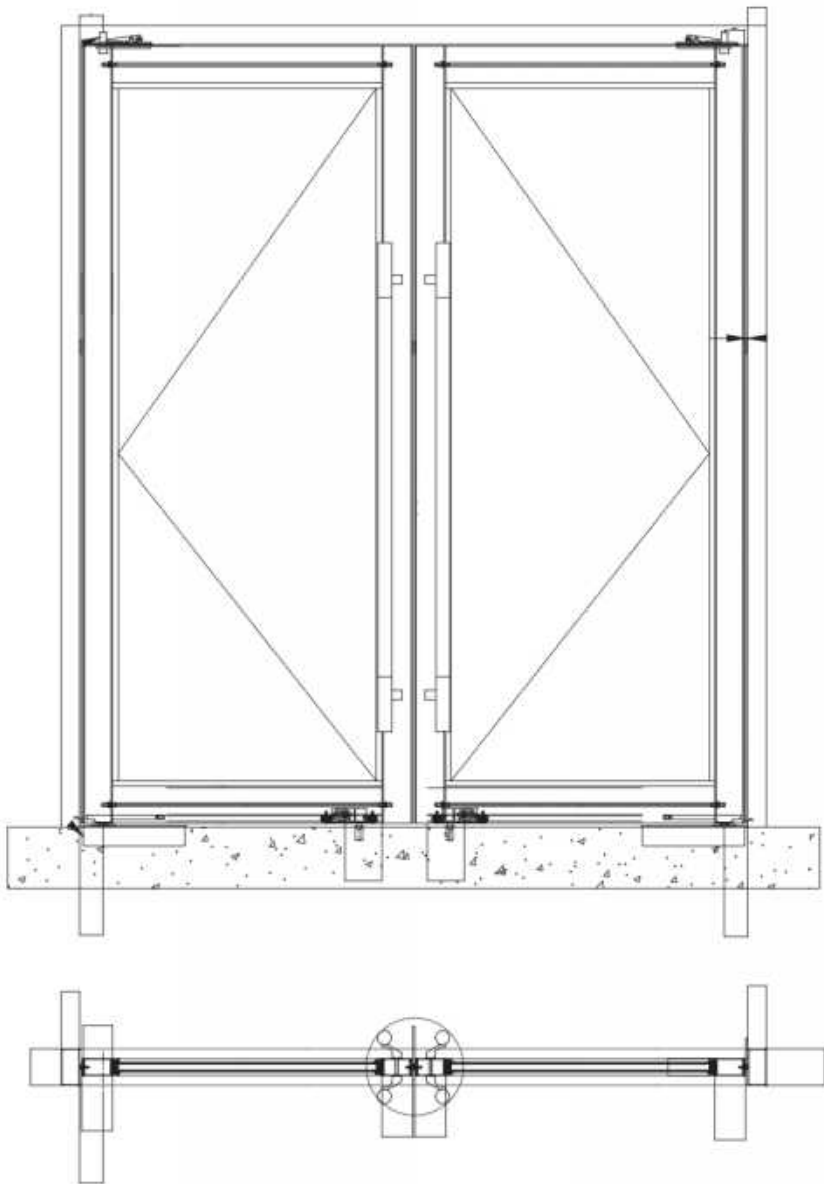

SHOWCASE GRAPH

# FIXED SKYLIGHT

## HIGH-END SYSTEM DOORS AND WINDOWS

### Technical Parameters:

Frame thickness: 1.5mm

### Size rang:

Sash width 500mm-1500mm, Sash height 500mm-1500mm

### Glass specification:

5mm+27A+5mm double clear tempered glass

### Product function:

Fixed window

### Product advantage:

1. That this series is made of 6063 profiles, which has high quality, and is strong, durable, corrosion resistant.
2. 5+27A+5 double-layer hollow tempered glass, its transmission performance is better, more safe and stable
3. 27A large hollow design, its sound insulation and heat insulation performance is better.
4. Outer flat frame design drives no water and dust accumulation

## PRODUCT ACCESSORIES

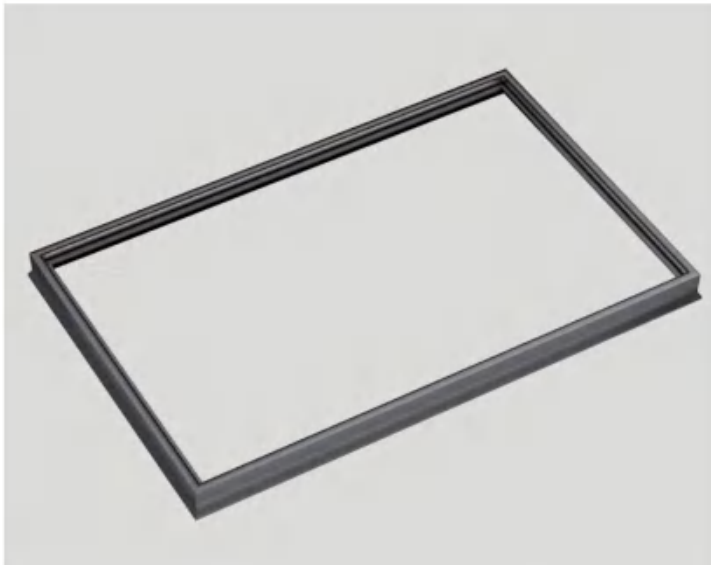

## HARDWARE CONFIGURATION



*Simplicity The minimalist design concept eliminates unnecessary decorations and creates a peaceful and comfortable living space.*

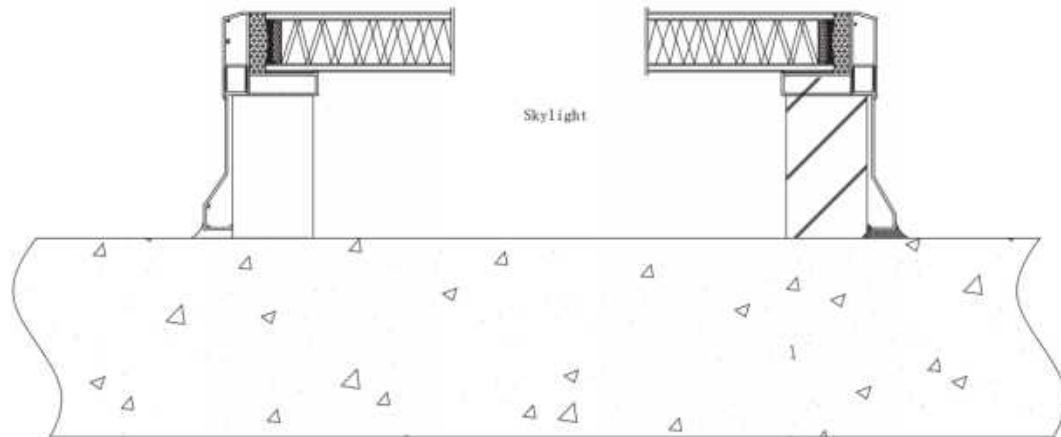

SHOWCASE GRAPH

# ELECTRIC SKYLIGHT

**HIGH-END SYSTEM  
DOORS AND WINDOWS**

## Technical Parameters:

Frame thickness: 1.5mm

## Size rang:

Sash width 600mm-1500mm, Sash height 500mm-1000mm

## Glass specification:

5mm+27A+5mm double clear tempered glass

## Product function:

Open flat

## Product advantage:

1. Laminated hollow glass can be selected, and its sound insulation and heat insulation effect is better
2. PVB laminated technology, has high efficiency UV isolation, while enhancing the impact resistance shock absorption function, effectively isolate the danger of falling objects.
3. Two rubber strips in the opening position, effectively prevent rainwater intrusion, and has better sealing effect.



## PRODUCT ACCESSORIES



Motor



Remote

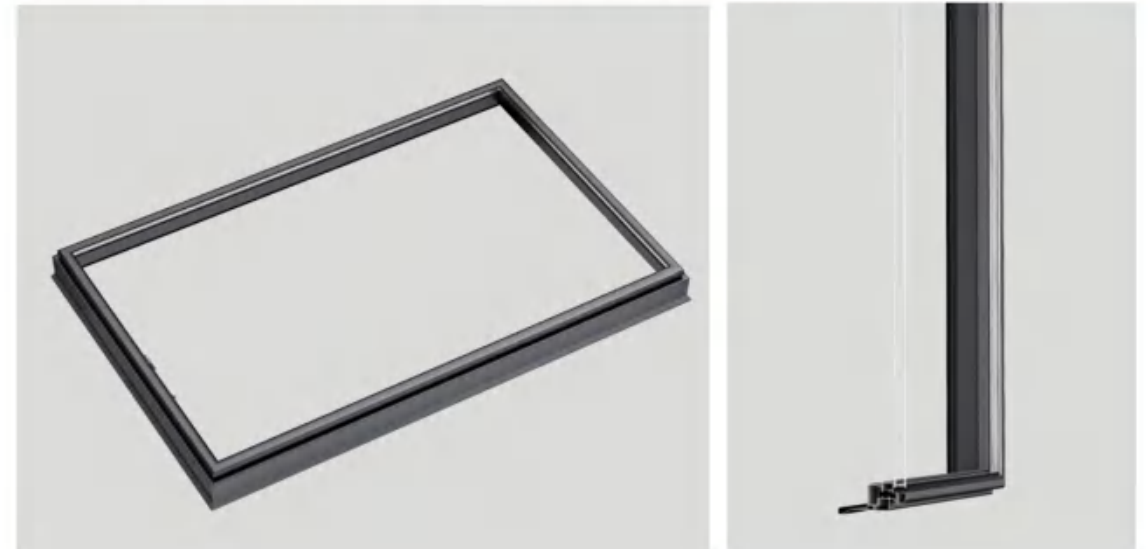

HARDWARE CONFIGURATION

*Simplicity The minimalist design concept eliminates unnecessary decorations and creates a peaceful and comfortable living space.*

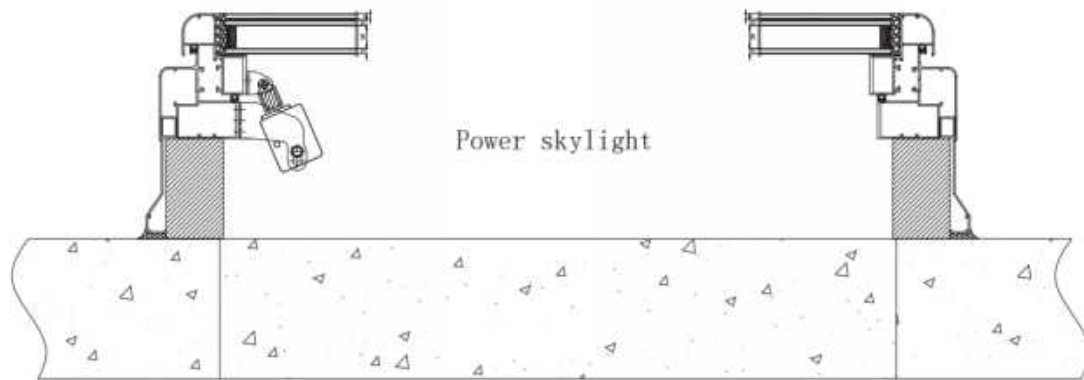

SHOWCASE GRAPH

# 4516 SERIES

CASEMENT DOOR

# HIGH-END SYSTEM DOORS AND WINDOWS

### Technical Parameters:

Frame thickness: 1.4mm

### Size rang:

Sash width 600mm-850mm, Sash height 500mm-2400mm

### Glass specification:

8mm Single layer tempered oil sand glass

### Product function:

Swing door

### Product advantage:

1. Adopting 6063 profile, which has high quality, is sturdy and durable, and has good corrosion resistance
2. Adopting invisible flat hinges, which is simple one-piece design, look fashionable and beautiful
3. Narrow bezel design fills every corner with a sense of luxury

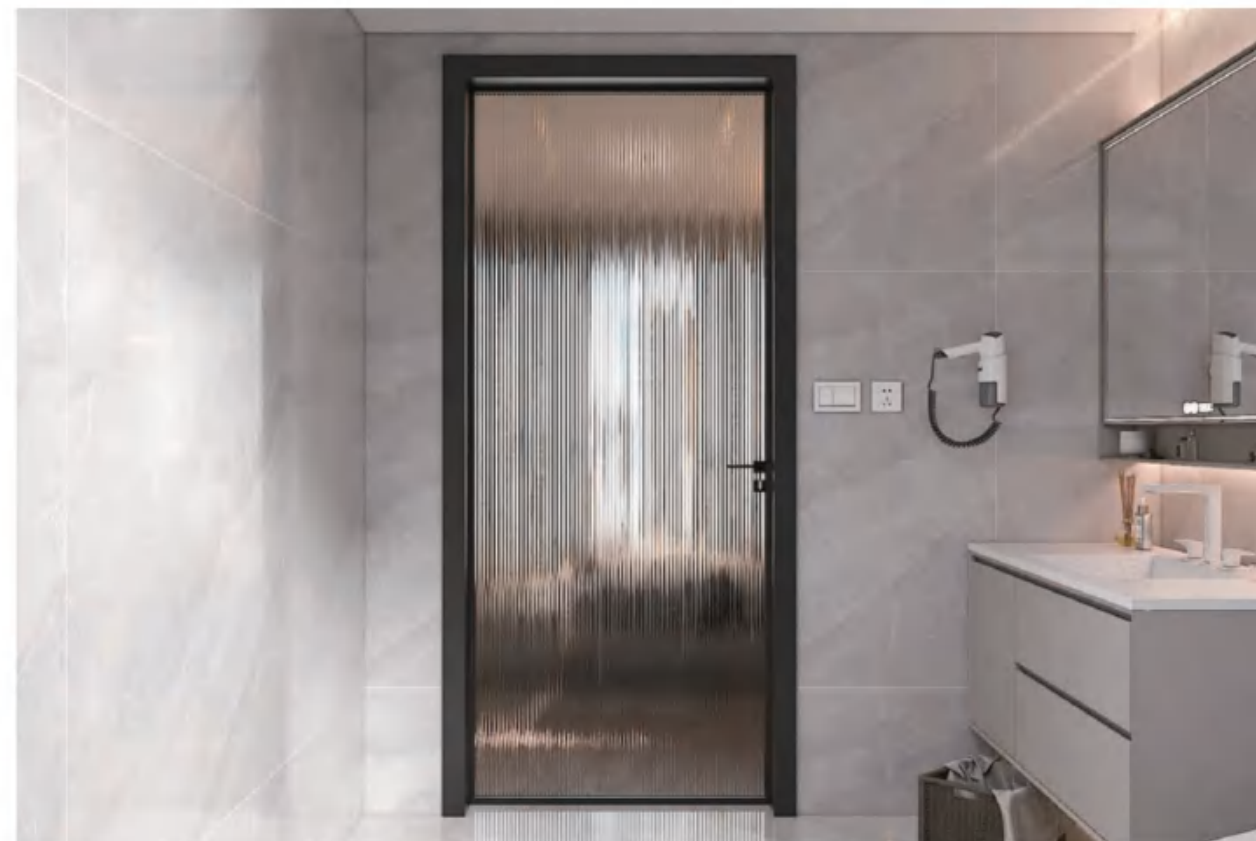

## PRODUCT ACCESSORIES



Handle



Lock Cylinder with Keys

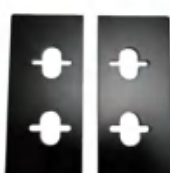

Handle Set



Invisible Hinges/Lock Set/  
Upper and Lower Bolts



Lock Body

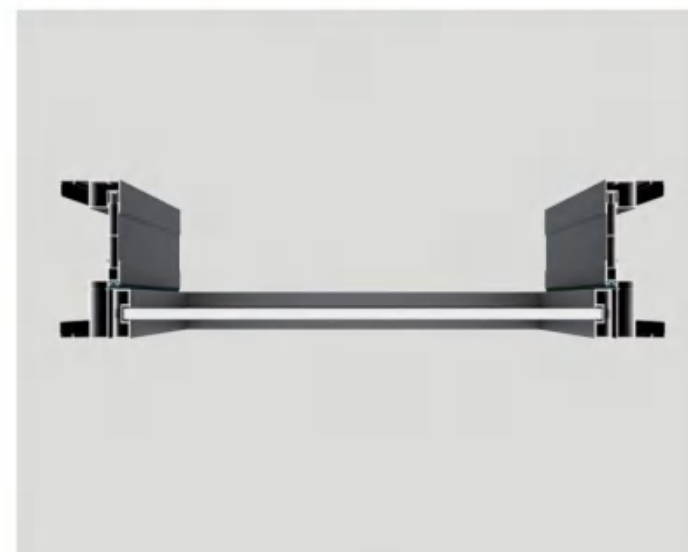

## HARDWARE CONFIGURATION

*Simplicity The minimalist design concept eliminates unnecessary decorations and creates a peaceful and comfortable living space.*

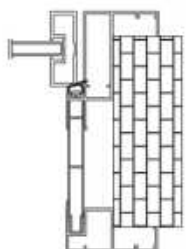
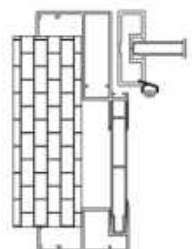
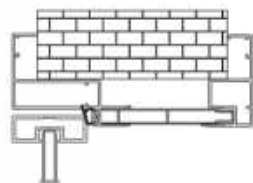
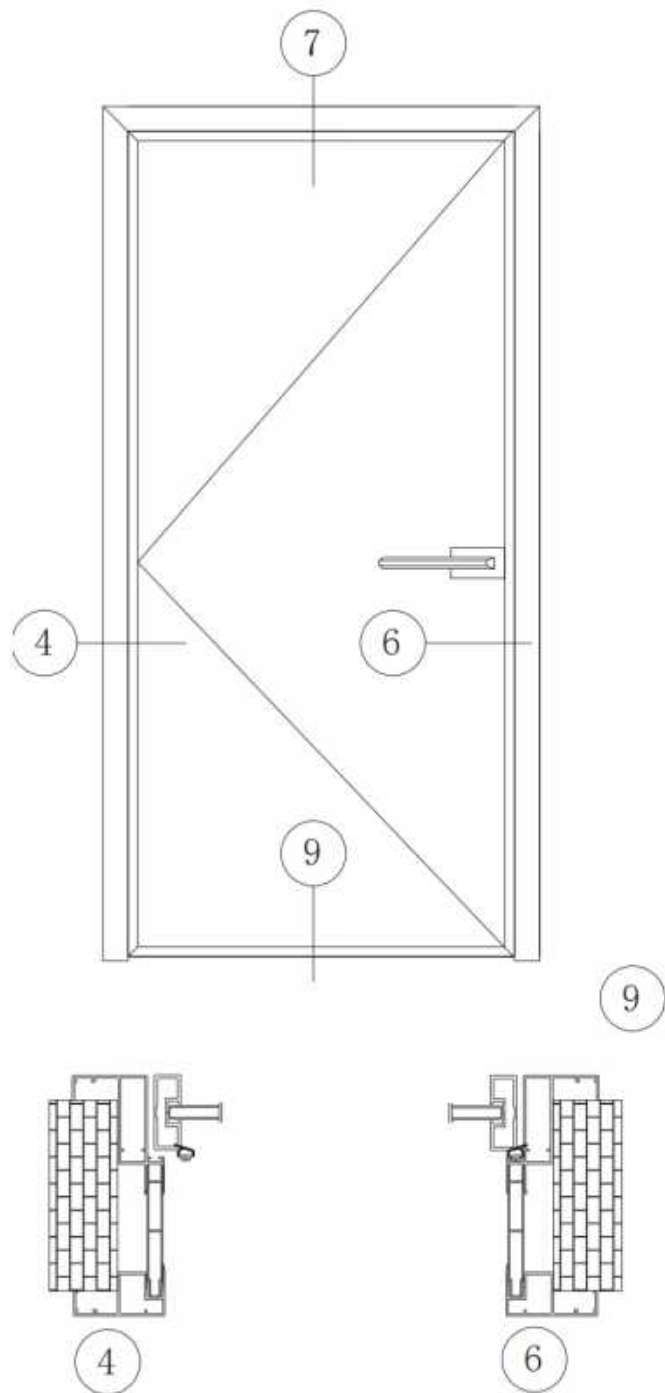

SHOWCASE GRAPH

# 4535 SERIES

CASEMENT DOOR

## HIGH-END SYSTEM DOORS AND WINDOWS

### Technical Parameters:

Frame thickness: 1.4mm

### Size rang:

Sash width 600mm-850mm, Sash height 500mm-2400mm

### Glass specification:

4mm+15A+4mm double clear tempered glass

### Product function:

Sliding door Two/three/four/six

### Product advantage:

- 1、 Adopting 6063 profile, high quality, sturdy and durable, corrosion resistance
- 2、 Adopt stainless steel hinges, no rust and oxidation resistance, strong load-bearing capacity
- 3、 Smooth frame and fan surface, fresh and elegant, green and environmental protection
- 4、 Can be made of lattice, craft glass and other styles with home style

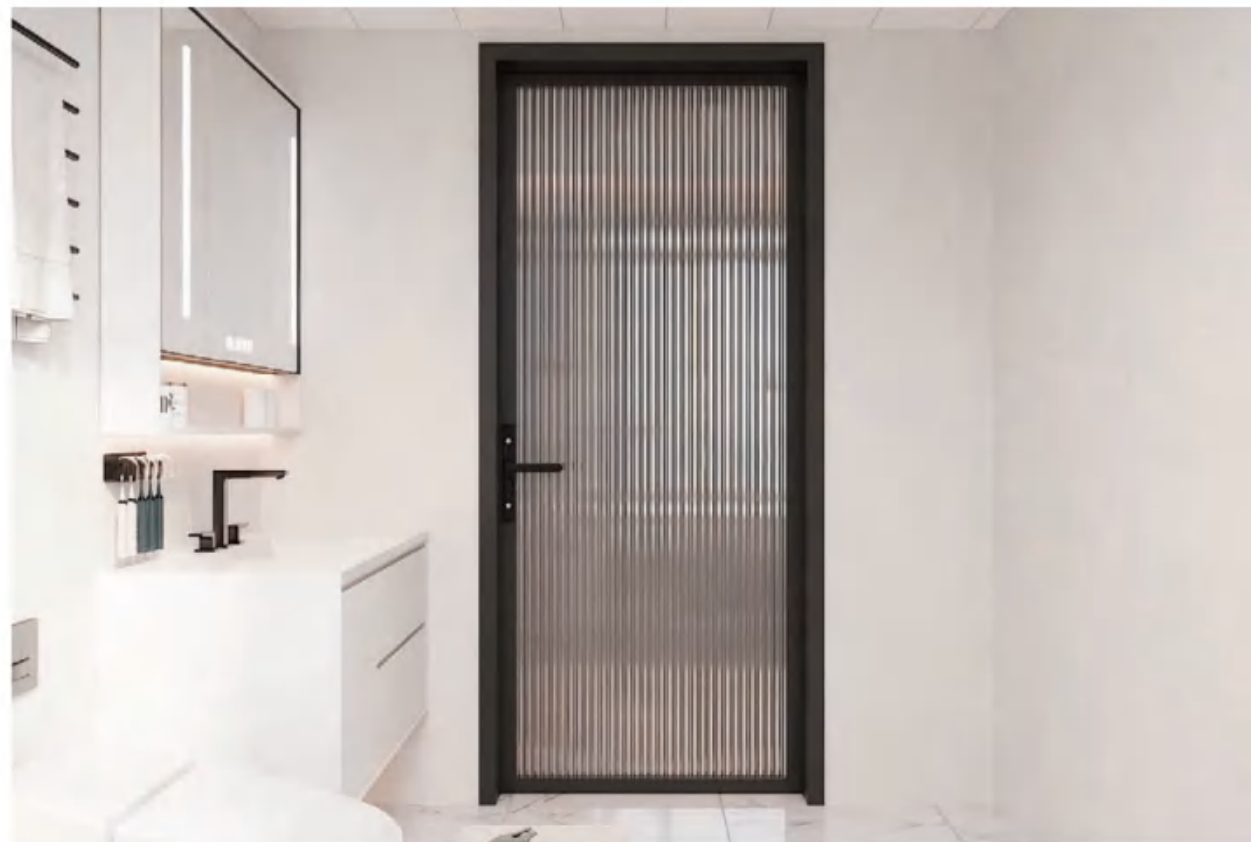

### PRODUCT ACCESSORIES



Visible Hinges/Door Handle



## HARDWARE CONFIGURATION

*Simplicity The minimalist design concept eliminates unnecessary decorations and creates a peaceful and comfortable living space.*

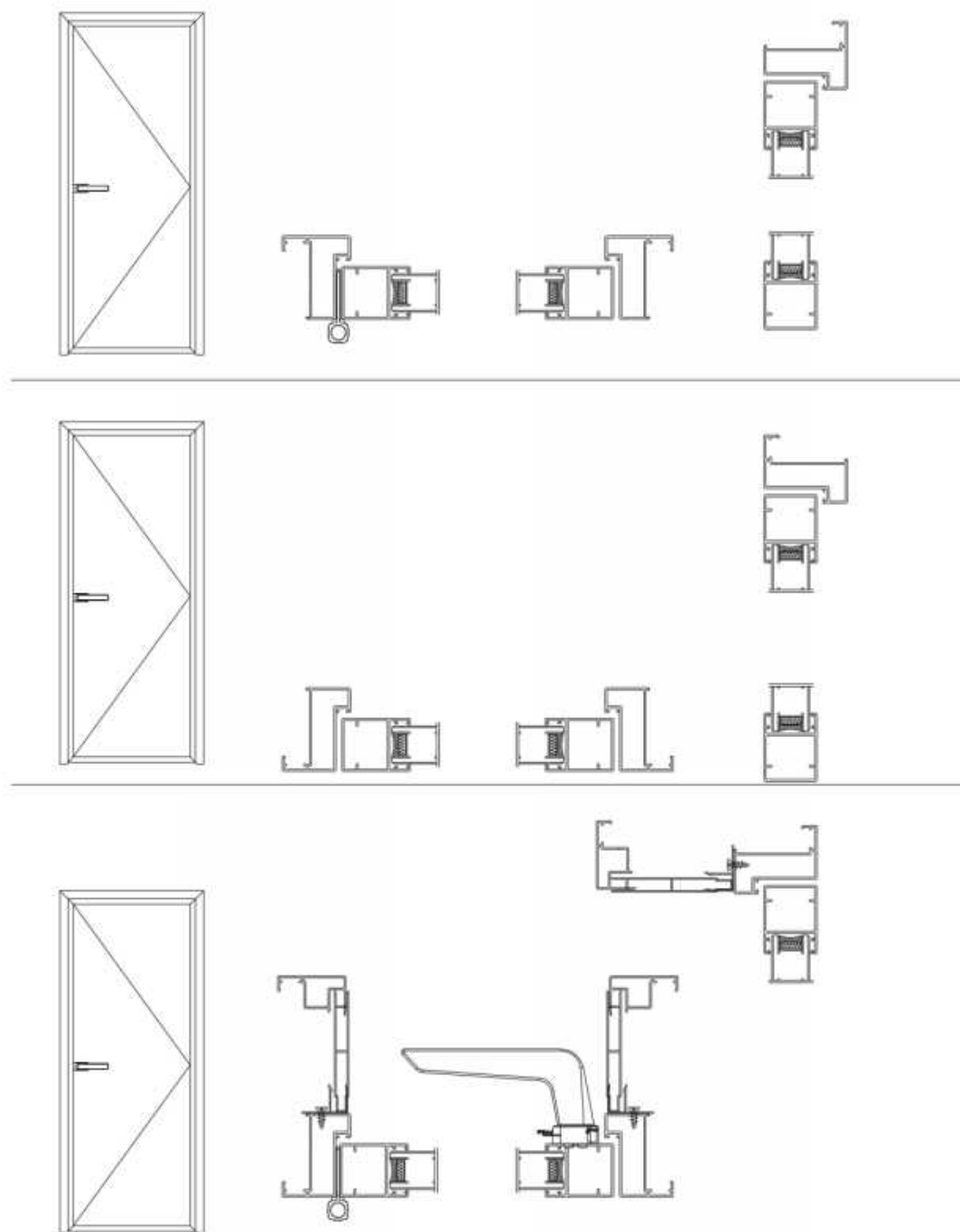

SHOWCASE GRAPH

# 4516 SERIES

SLIDING DOOR

# HIGH-END SYSTEM DOORS AND WINDOWS

### Technical Parameters:

Frame thickness: 1.4mm

### Size rang:

Sash width 600mm-850mm, Sash height 500mm-2400mm

### Glass specification:

8mm Single layer tempered oil sand glass

### Product function:

Sliding door Two/three/four/six

### Product advantage:

1. Appearance of product is elegant and generous
2. Embedded structure design has better air and water tightness
3. Extremely narrow design highlights modern fashion trends
4. The door saves space and is easy to clean and maintain
5. Column-free corner design can be selected to eliminate visual obstacles and allow for a more open and airy space



## PRODUCT ACCESSORIES



Linkage components 2



Hanging Wheels



"1"Shaped Pull Handle, Circle Pull Handle



buffers



Hanging Wheels 3



Linkage components



"回"Shaped Pull Handle



Hanging Wheels 2



Upper Anti-Swing Wheels

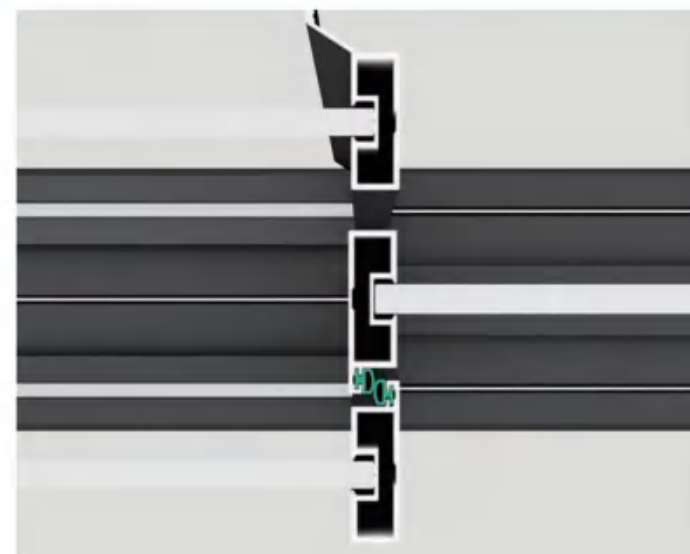

## HARDWARE CONFIGURATION

Simplicity The minimalist design concept eliminates unnecessary decorations and creates a peaceful and comfortable living space.

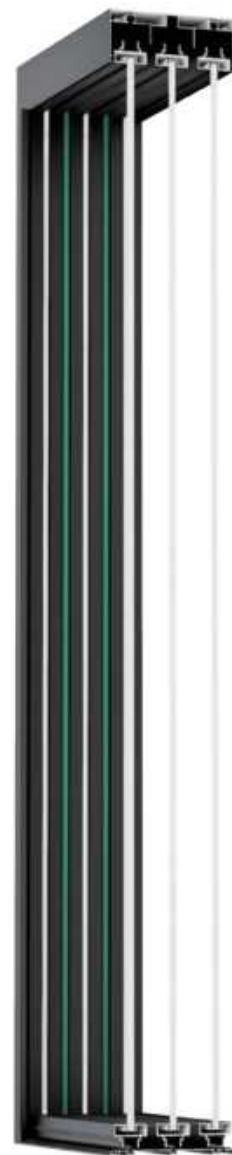
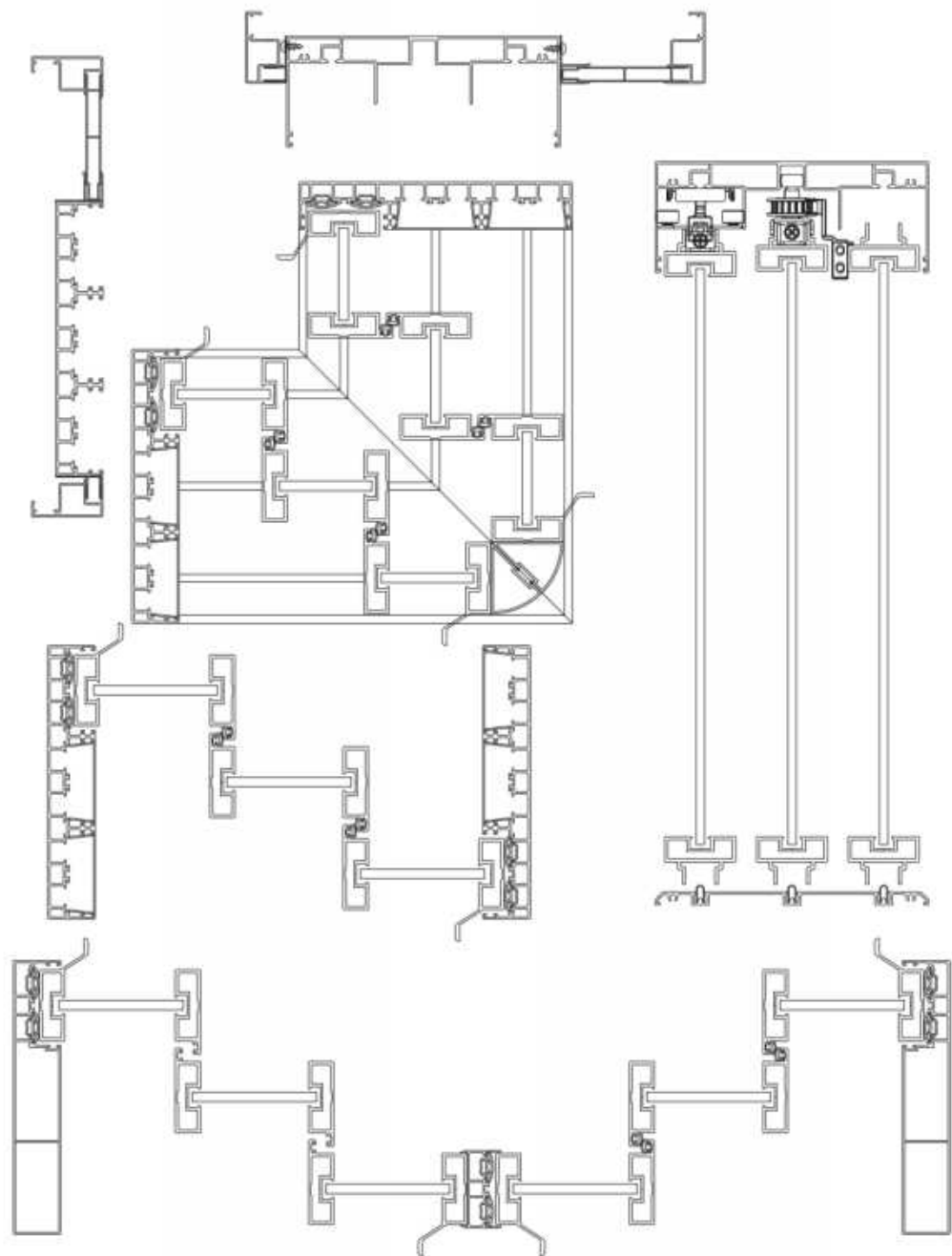

SHOWCASE GRAPH

# 4535 SERIES

CASEMENT DOOR

## HIGH-END SYSTEM DOORS AND WINDOWS

### Technical Parameters:

Frame thickness: 1.4mm

### Size rang:

Sash width 600mm-850mm, Sash height 500mm-2400mm

### Glass specification:

4mm+15A+4mm double clear tempered glass

### Product function:

Sliding door Two/three/four/six

### Product advantage:

1. The product appearance design is fashionable and simple, outstanding value
2. Adopting stainless steel axis, carbon fiber pulley, push and pull 100,000 times without failure
3. Medium and narrow design, the sense of the times and stability highlights the low-profile
4. Can be made of lattice strips, craft glass and other styles with home style



### PRODUCT ACCESSORIES



Lock, Upper Wheels, Lower Wheels

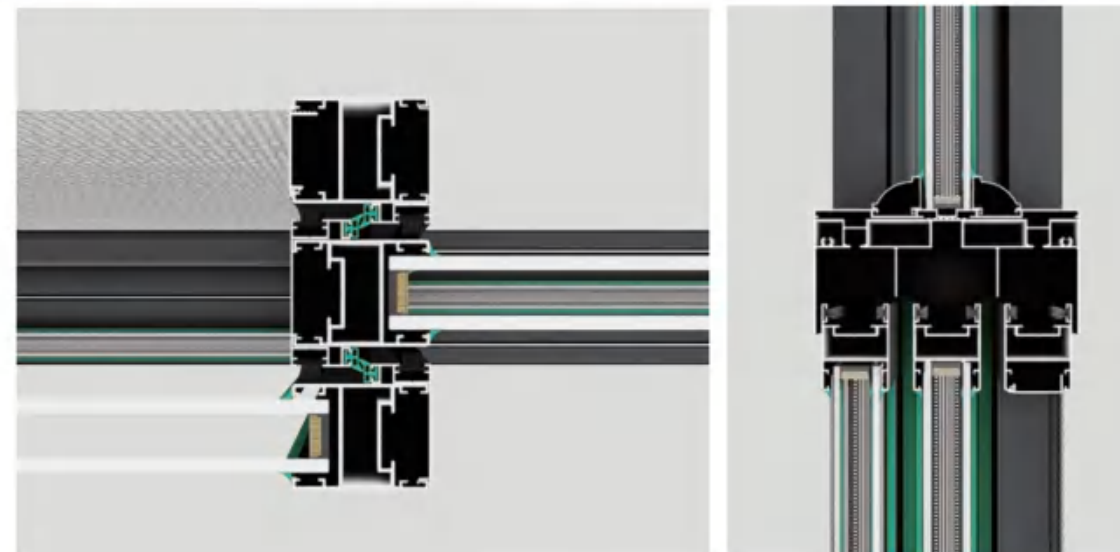

## HARDWARE CONFIGURATION

*Simplicity The minimalist design concept eliminates unnecessary decorations and creates a peaceful and comfortable living space.*

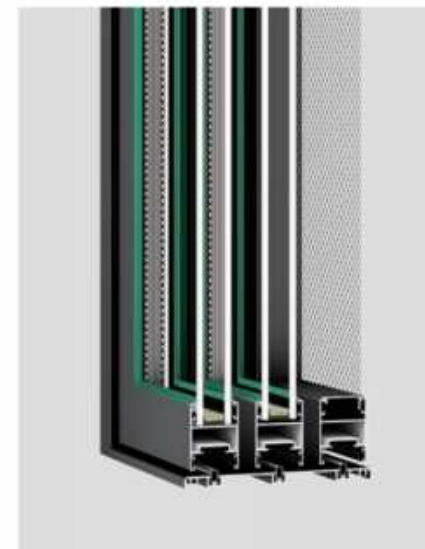
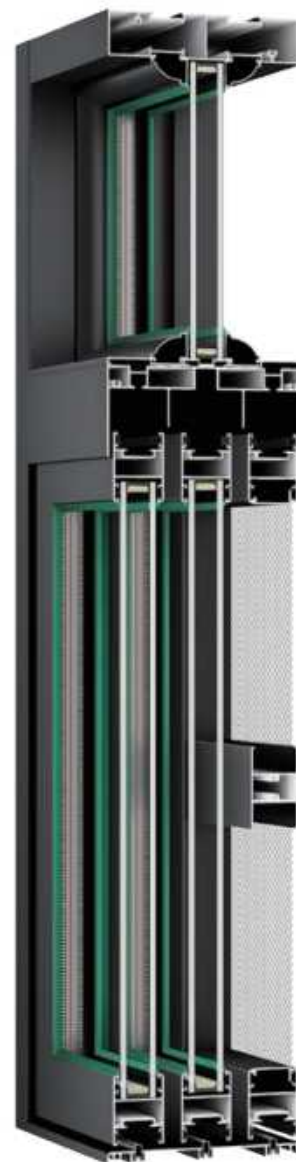
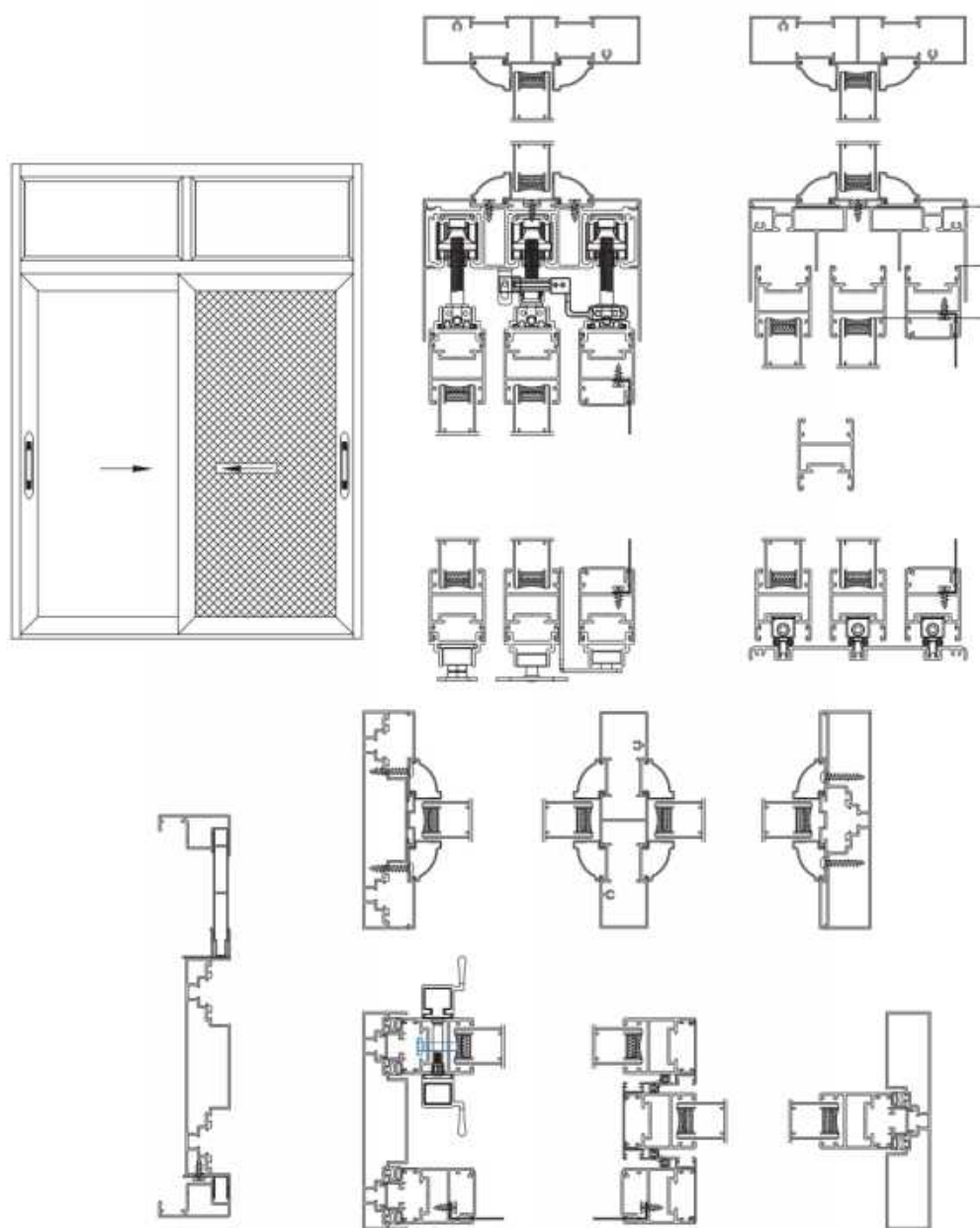

SHOWCASE GRAPH

# PANORAMIC TWO-TRACK THERMAL BREAK SLIDING DOOR

# HIGH-END SYSTEM DOORS AND WINDOWS

## Technical Parameters:

Frame thickness: 2.0mm

## Size rang:

Sash width 600mm-5000mm, Sash height 800mm-3500mm

## Glass specification:

6mm+25A+6mm double clear tempered glass

## Heat insulation strip:

14.8mm

## Product function:

Sliding door Two tracks with two panels/Two tracks with four panels/Three tracks with three panels/three tracks with four panels/four tracks with four panels/four tracks with eight panels/five tracks with five panels/five tracks with ten panels Two electric fans/Three electric fans

## Product advantage:

1. Micro-seam lower track design, compared with the traditional sliding track is more beautiful, and has better drainage performance
2. When in the closed state, the frame wraps the sash design will be more stable, have higher wind pressure resistance
3. Double rows of customized stainless steel pulleys, with a load capacity of up to 1500kg for a single door



## PRODUCT ACCESSORIES

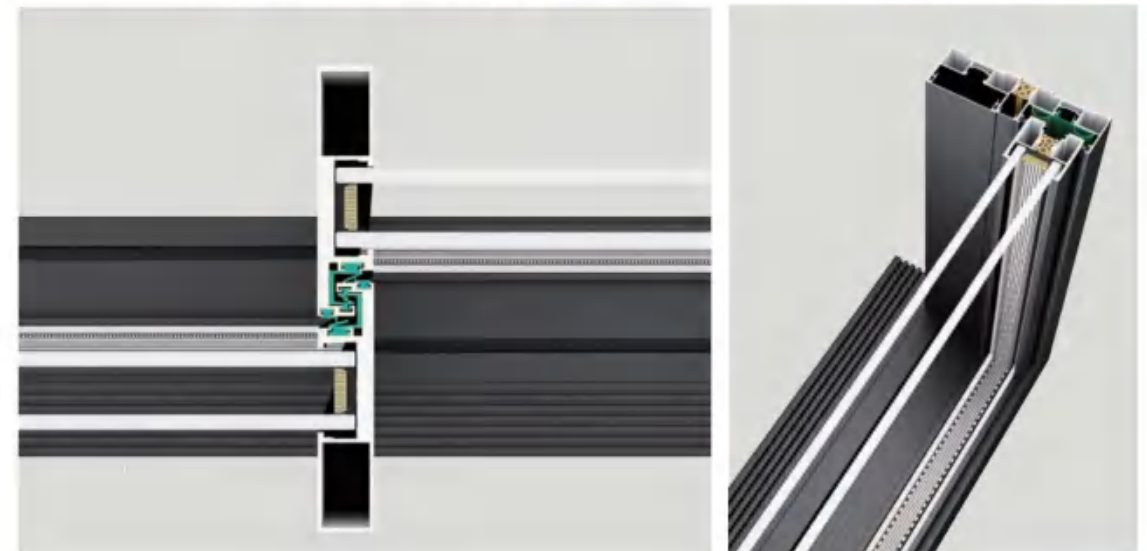

## HARDWARE CONFIGURATION

Simplicity The minimalist design concept eliminates unnecessary decorations and creates a peaceful and comfortable living space.

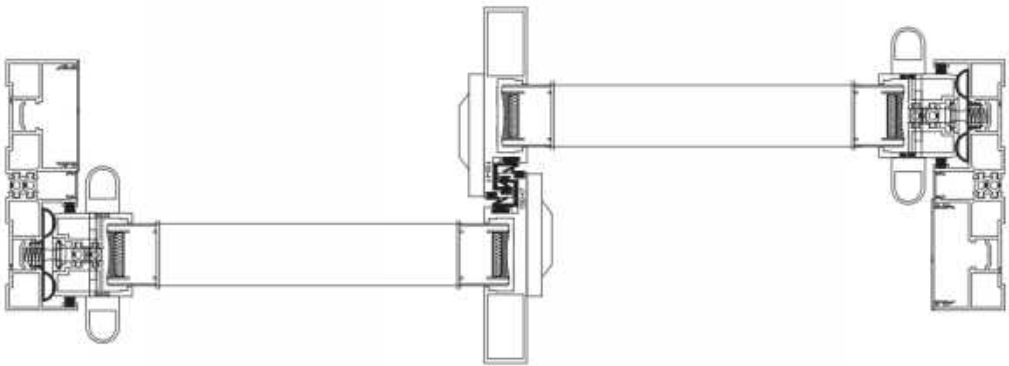
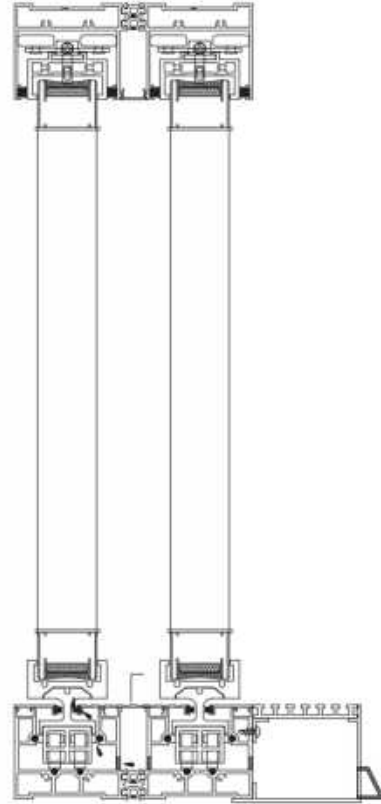
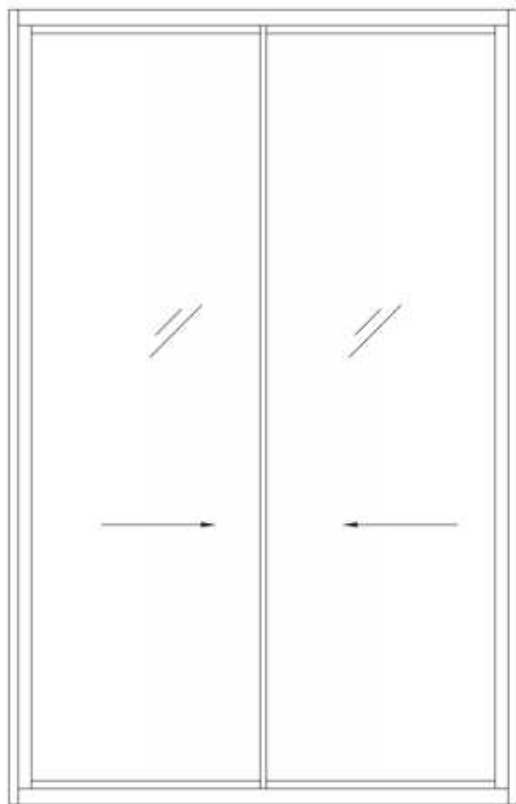

SHOWCASE GRAPH

Foshan Desilesi Home Technology Co., Ltd.  
<http://www.zekindw.com>  
<http://www.zekinwindow.com>  
email:yeeclaire86@gmail.com